

TECHNICAL MANUAL WEIGHT INDICATOR

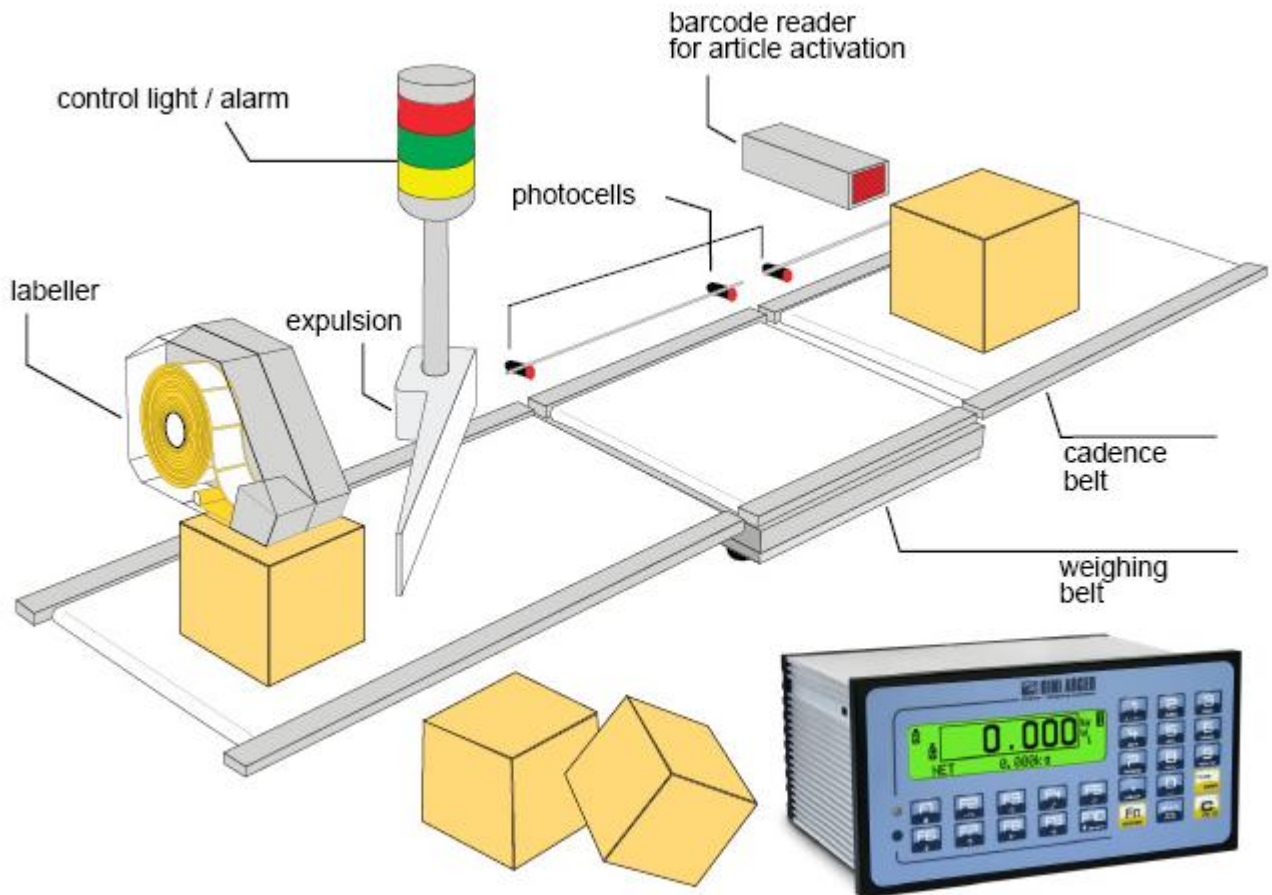

E-CHECK: STATIC OR DYNAMIC WEIGHT CONTROL ON BELT



3590EXT, CPWE series indicator



INDEX

1. REQUIREMENTS FOR AN EFFECTIVE INSTALLATION	2
1.1 ELECTRICAL PRECAUTIONARY MEASURES	2
1.1.1 CABLE CLASSIFICATION.....	3
1.1.2 RECOMMENDED DISTANCES AMONG CABLES	3
1.1.3 MAXIMUM CABLE LENGTH	4
1.2 EARTHING SYSTEM	4
2. INSTALLING.....	5
2.1 WEIGH MODULE	5
2.2 WEIGHING BELT	6
2.3 CADENCE BELT	7
2.4 DOWNSTREAM BELT	8
2.5 CYCLE ENABLING AND RESTARTING COMMANDS.....	8
2.6 ALARM, EXPELLER AND TRAFFIC LIGHT / SORTER.....	8
3. SETUP ENVIRONMENT	9
3.1 SET-UP ENVIRONMENT BLOCK DIAGRAM	11
3.2 DESCRIPTION OF THE STEPS	16
4. CALIBRATION.....	49
4.1 CALIBRATION PROCEDURE.....	49
4.2 LINEARISATION POINTS	51
4.3 ZONE OF USE DIFFERENT THAN THE ZONE OF CALIBRATION:.....	52
4.4 QUICK ZERO CALIBRATION	52
5. DISPLAY OF THE GRAVITY ACCELERATION AND CORRECTION OF THE WEIGHING ERROR DUE TO THE DIFFERENT GRAVITATIONAL ACCELERATION BETWEEN CALIBRATION ZONE AND UTILISATION ZONE. ...	53
6. FUNCTION OF THE OPTOISOLATED INPUTS.....	54
7. FUNCTION OF THE OUTPUTS	55
8. SERIAL OUTPUTS	56
8.1 RS 485 CONNECTION	57
8.2 PC CONNECTION	59
8.3 PRINTER CONNECTION.....	59
8.4 TRANSMISSION PROTOCOLS.....	59
8.5 TRANSMISSION MODES	61
8.6 SERIAL COMMANDS FORMAT	61
9. ANALOGUE OUTPUT (OPTIONAL)	64
9.1 OPERATING MODES	64
9.1.1 OUTPUT ON THE GROSS WEIGHT	64
9.1.2 OUTPUT ON THE NET WEIGHT	66
9.1.3 OUTPUT WITH VALUE FROM THE ARTICLE FOR THE BELT SPEED MANAGEMENT	66
9.2 CONFIGURATION	67
10. PROGRAMMING THE PRINTOUTS.....	68
10.1 PROGRAMMING EXAMPLE.....	70
10.2 ASCII CODE TABLE	71
10.3 LIST OF PRINT BLOCKS.....	73
10.3.1 ORDER BY KIND	73
10.3.2 NUMERICAL ORDER.....	79
10.4 BLOCKS WITH PARAMETERS	84
11. ELECTRICAL SCHEMES	91
11.1 BACK PANEL.....	91
11.2 MOTHER BOARD	92
9.2 I/O EXPANSION BOARD (fitted with 3590EXT in IO version or CPWE).....	95
9.3 I/O EXPANSION SOCKET INSTALLATION.....	96
9.4 DISPLAY BOARD	98
9.4 CONTROL LIGHT	98



1. REQUIREMENTS FOR AN EFFECTIVE INSTALLATION



To obtain the best results it is recommended to install the indicator and the platform (or transducer) in a place with the following conditions:

A flat, level surface on which to rest

Stable and vibration free

No dust or strong vapours

No draughts

Make sure the platform is level or that the loading cells are resting evenly

Moderate temperature and humidity (15-30°C and 40-70%)

Do not install anywhere where there is the risk of explosion

All the indicator connections have to be made respecting the rules applicable in the zone and in the installing environment. Respect the recommended electrical precautionary measures described in section “ELECTRICAL PRECAUTIONARY MEASURES”.

Make sure that the grounding is made correctly, see section “EARTHING SYSTEM”.

Everything not expressly described in this manual has to be considered as improper use of the equipment.

Avoid welding with load cells installed.

Use waterproof sheaths and couplings in order to protect the load cell cables.

Use a waterproof junction box to connect the cells.

1.1 ELECTRICAL PRECAUTIONARY MEASURES

Mains power supply is restricted to within $\pm 10\%$ of the rated voltage

Electric protections (fuses etc.) are provided by the technician installing the instrument.

Respect the recommended minimal distances that are mentioned for the various cable categories, see sections “CABLE CLASSIFICATION” and “RECOMMENDED DISTANCES AMONG CABLES”.

The extension leads of the load cells or signal amplifiers, used for the connection of the serial ports and analogue output must be within the allowed maximum lengths, see section “MAXIMUM CABLE LENGTH”.

The extension leads of the load cells or signal amplifiers must be screened. In addition they must be laid on their own in a raceway or metal pipe as far away as possible from the power supply cables.

Install “RC” filters on the contactor coils, on the solenoid valves and on all devices producing electric disturbances.

If it is possible that condensation could form inside the weight transmitter it is advisable to leave the instrument powered at all times.

Every shielded cable or not (for instance PC cable, cell cable, power supply cable) connected to the indicator should be as shorter as possible, then you have to come out of the shield the minimum length of cable, then connect to the terminal box;

If the indicator is situated inside an electric panel, the power supply cable should be a shielded cable as shorter as possible, distant from every coil supply cable, inverter, electromotive force, etc. and in addition dedicate an uncoupler transformer in order to feed the indicator only.

1.1.1 CABLE CLASSIFICATION

The various cables are classified depending on the transmitted signals:

Category I

- Field bus, LAN
- Shielded data cables (RS232 ...)
- Shielded cables for analogue/digital signals < 25V (sensors, load cells...)
- Low tension power supply cables (< 60V)
- Coaxial cables

Category II

- DC supply cables with tension > 60V and < 400V
- AC supply cables with tension > 25V and < 400V

Category III

- Power supply cables with tension > 400V
- Telephone cables

Category IV

- Any cable subject to lightning

1.1.2 RECOMMENDED DISTANCES AMONG CABLES

- When the cables are laid next to each other, these must be at the distances in the table below
- These distances are valid if in the air; these are reduced if the raceways are separated by grounded metallic shields.
- Different category cables can cross each other (90°)

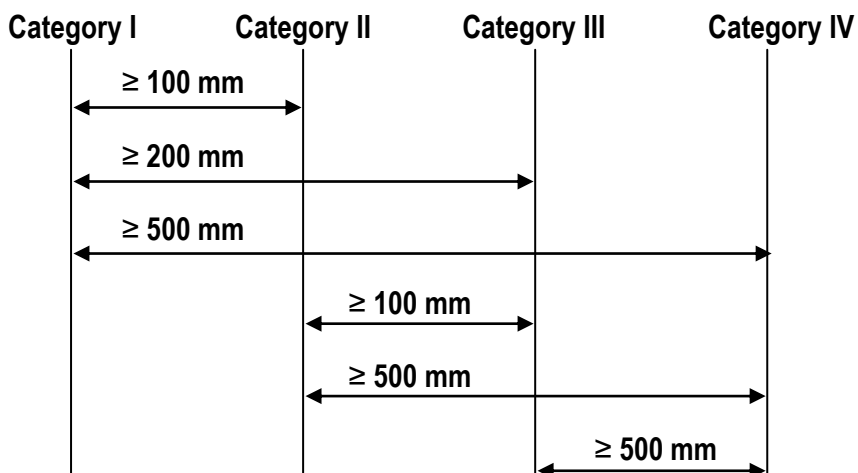

1.1.3 MAXIMUM CABLE LENGTH

LOAD CELL CABLE

The maximum reachable length from the line using the appropriate load cell cable is:

- 50 m with cable 6 x 0,25 mm²
- 100 m with cable 6 x 0,5 mm²

RS232 CABLE

The maximum reachable length from the line using the RS232 cable with a maximum baud rate of 19200, is about 15 m.

RS485 CABLE

The maximum reachable length from the line with the use of the appropriate cable for RS 485 connections (see section "RS 485 CONNECTION"), and with baud rate up to 9600, is about 1200 meters.

ANALOG OUTPUT CABLE

The maximum length of the analogue output cable in current is:

- 100 m with cable 2 x 0,25 mm²
- 150 m with cable 2 x 0,5 mm²
- 300 m with cable 2 x 1 mm²

The maximum length of the analogue output cable in voltage is:

- 50 m with cable 2 x 0,25 mm²
- 75 m with cable 2 x 0,5 mm²
- 150 m with cable 2 x 1 mm²

1.2 EARTHING SYSTEM

For the right earthing and the optimal functioning of the system, it is necessary to create a point of ground in proximity to the indicator, on which connect the ground wire (of the indicator) and its shielded cables, see the next paragraph "POINT OF GROUND OF THE INDICATOR".

Connect the load cells, the possible junction box, the weighing structure and the ground point of the indicator directly to the earth bar of the panel (if present), or to a grounding pole, according to the type of application, this will be called the common point of ground.

POINT OF GROUND OF THE INDICATOR

Create a point of ground in proximity to the indicator, in which one connect the earth of the indicator and the shielded cables connected (load cell cable, serial ports cables, etc). For example one can use an end connector terminal block, then connect this point to the ground using a cable having a 4mm² cross-section.

Connect the terminal 24 (EARTH SHIELD) and the case earthing to the common point of ground.

LOAD CELLS AND JUNCTION BOX

- In the case the load cells are connected to the indicator through a junction box, it is necessary to connect the sheathing of the cells cables and indicator cable to the earthing of the junction box (refer to the junction box manual) and connect this to the earth.
- If the load cells are connected directly to the indicator (without the junction box), it is necessary to connect the shieldings of the load cell cables directly to the common point of ground, using a cable having a 4mm² cross-section if the common point of ground is situated a few meters, otherwise through a copper cable having at least a 16 mm² cross-section, or more for longer distances. In both cases it is also necessary:
- Connect to each cell, the top with the bottom of the cell through a copper braid having at least a 16 mm² cross section; the top should be short-circuited with the plane of the weighing structure, and the bottom must be connected to earth through a copper braid having at least a 16 mm² cross-section.
- All the grounding cables must have an adequate length, in order to obtain **an overall resistance of grounding system less than 1 Ω**.

LINK CONNECTOR STANDARD “DINI ARGO” FEMALE

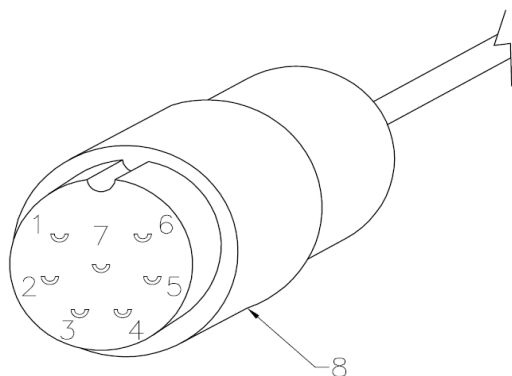

1. ALIMENTATION +
2. ALIMENTATION -
3. SENSE -
4. SENSE +
5. SIGNAL -
6. SIGNAL +
7. NOT CONNECTED
8. SCREEN (to be attached below the cable tie connector)

WEIGHING STRUCTURE

Connect the weighing structure and the possible connected structures (for example silos that release material on the weighing structure) to the earth through copper cables having at least a 16 mm² cross-section.

CONNECTED SERIAL CABLES AND INSTRUMENTS

Ground the cable's shield both at the common earthing point (at the cable termination on the indicator side) and at the earthing of the connected instrument (at the cable termination on the connected instrument side) and ground the earth connection of the connected instrument using the copper cables having at least a 16 mm² cross-section.

To avoid possible side effects, the earth references of the connection and power supply cable of the indicator and of the connected instrument **must be at the same potential**.

GENERAL NOTES:

- In the case the weighing system regards great and/or outdoor structures, like weighbridges:
 - the cable cross-section must be greater (for example 50 mm² instead of 16 mm² and 100 mm² instead of 50 mm²), because the voltage into play is greater (for example thunderbolts);
 - the ground pole must be positioned at a distance of at least 10 metres from the weighbridge structure;
 - one needs to open the SENSE inside the indicator in order to offset the drifts due to the increase in temperature.
- One should check and remove, if necessary, the connection between the earth and the neutral wire of the electrical installation.

2. INSTALLING

IMPORTANT: Respect the electrical precautionary measures shown in section “REQUIREMENTS FOR AN EFFECTIVE INSTALLATION”.

2.1 WEIGH MODULE

After having followed the instructions regarding the platform or weigh module, the screened cable leading from the load cell(s) must be connected to the instrument through the terminal board, see section “ELECTRICAL SCHEMES”.

The terminal board of the indicator may be connected to the 6-wire weigh module (with use of SENSE), or simply 4-wire; for

this, through jumper J7 and J8 it is possible to choose whether to short-circuit the SENSE with the POWER SUPPLY (jumpers closed) or not (jumpers open).

The sense allows compensating for any drops in voltage in the part of the cable that connects the instrument to the transducer. It is useful when the distance between the indicator and the transducer is greater than 10 m.

The 4-pin connectors instead allow just the 4-wire connection.

To make the connection qualified personnel must open the instrument (see terminal board connections section "ELECTRICAL SCHEMES").

TAKE NOTE: if there is A SINGLE LOAD WEIGH MODULE, it is possible to make a 6-wire connection (use of the sense) directly to the terminal board, removing the J7 and J8 jumpers.

If there are two or MORE WEIGH MODULES, one should close the J7 and J8 jumpers (sense and power supply short-circuited) and make the 4-wire connection.

Normally the indicator comes already connected to the platform and is ready to use. If this is a LEGAL version instrument, access to the connection will be subject to a legal SEAL.

Follow the instructions for preparing the platform for use.

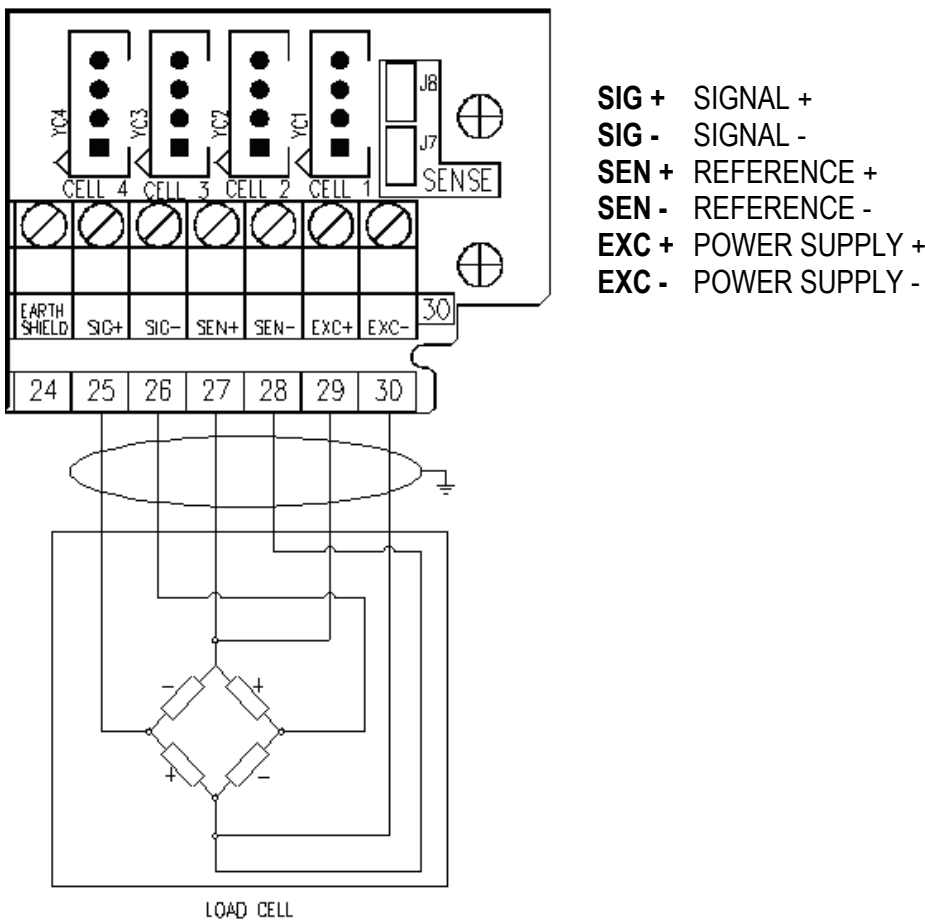

See section "ELECTRICAL SCHEMES" for further information.

2.2 WEIGHING BELT

The system must be made so that it contains the vibration caused by the movement of the belt.

It is furthermore important to pay attention to the disposition of the cable from the belt (motor), in order to avoid disturbances during the acquisition of the weigh.

In the weighing in movement, the belt speed must be regulated in order to allow a sufficient time for the data acquisition.

In any case it is advisable to regulate the belt speed at the same speed of the cadence belt or vice versa, in order to avoid further vibration on the system.

CORNER EQUALIZATION

To obtain the highest performance, in terms of precision, one has to verify the weight difference between the corners.

If necessary, execute the equalization of the corners, depending on the type of application made, in order that the result, both statically and dynamically, depends as little as possible on the pack position.

In the dynamic weighing mode, it is essential to have the equalized signal between the start and the end of the weighing belt.

COMMAND OUTPUT FOR THE WEIGHING BELT

The indicator's terminal is fitted with the OUT2 output at N.O. contact, managed by the instrument for enabling / disabling the weighing belt (closed contact to enable the belt)

In case one executes the weigh by manually positioning the pack, and it is required to enable the belt only when the weight is acquired (to execute the automatic evacuation), it is possible to use the tolerances output, from OUT5 to OUT11 (see section "FUNCTION OF THE OUTPUTS"), or the expulsion output, OUT4, all managed in the evacuation phase.

START AND STOP WEIGH PHOTOCELLS

If it is required, it is possible to install 2 photocells on the weighing belt, which are to be connected to the indicator in order to control the weight acquisition weigh; the instrument's terminal is fitted with:

- IN2 input (start photocell), required in all the functioning modes with photocells, to command the start of weighing operations;
- IN5 input (stop photocell), required in the functioning mode with 2 photocells, to command the end of weighing operations;

The photocells must be positioned respectively at the start and at the end of the weighing belt.

NOTE: For the connection of the inputs and outputs, follow the electrical schemes at section "ELECTRICAL SCHEMES".

2.3 CADENCE BELT

For the optimal acquisition of the weighs, it is required to regulate the distance between the packs, in order to guarantee the affluence with only a pack at a time on the weighing belt.

Furthermore, to avoid the affluence of further packs on the stopped belt, it is required to control the cadence belt by verifying also the instrument's outputs.

If the distance between the packs is already externally regulated it is sufficient to manage the cadence belt stop when the weighing belt has stopped.

COMMAND OUTPUT AND PHOTOCELL FOR THE CADENCE MANAGEMENT

The indicator's terminal is fitted with the OUT1 output at N.O. contact, managed to enable / disable the cadence belt (closed contact to enable the belt), in order to regulate the distance between the packs, where these are not already externally regulated.

To disable the cadence belt the instrument has to manage a photocell that tests the presence of the pack on the cadence belt, in order to stop the belt only if necessary.

In order to do this, the instrument's terminal is fitted with the IN3 input, for the connection of the CADENCE photocell.

NOTE: For the connection of inputs and outputs, follow the electrical schemes at section "ELECTRICAL SCHEMES".

2.4 DOWNSTREAM BELT

For the optimal evacuation of the pack at the end of the weigh acquisition, in particular during the stops, it is required to stop the downstream belt when the weighing belt has stopped, by verifying the OUT2 output at N.O. contact (closed contact to enable the belt).

CONSENSUS FROM DOWNSTREAM MANAGEMENT

During a block or a processing phase on the downstream belt, it may be required to stop the weighing belt, to avoid the flow of further packs.

The management of the weighing belt block must be done through the cycle enabling IN1 input (close input to enable the cycle).

It is important to disable the input at the end of the eventual weigh in progress, in order to avoid its cancellation; it is possible to set a block delay in order to allow the end of the eventual weigh under way, when the input is disabled without verifying the weighing belt status (see the << **rit.bLk** >> step).

NOTE: For the connection of inputs and outputs, follow the electrical schemes at section "ELECTRICAL SCHEMES".

2.5 CYCLE ENABLING AND RESTARTING COMMANDS

To start the automatic weighing cycle, and consequently the enabling of the input/output section, the instrument's terminal is fitted with the IN1 input (closed input to enable the cycle).

It is possible to exclude the management of this input, in order that the cycle is always enabled (see << **diS.d.st** >> step).

Furthermore, during the weighing cycle, depending on the configured functioning mode, it is possible to wait for an external command before restarting the system (for example after an error condition).

To do this, the instrument's terminal is fitted with the IN4 input (input closed for an instant to restart).

NOTE: For the connection of inputs and outputs, follow the electrical schemes at section "ELECTRICAL SCHEMES".

2.6 ALARM, EXPELLER AND TRAFFIC LIGHT / SORTER

The indicator' terminal is fitted with:

- OUT3 output with N.O. contact, managed to indicate an error status
- OUT4 output with N.O. contact, managed for the automatic expulsion of the out of tolerance pack (closed contact to indicate the reached level) in order to control a traffic light or divert the product through a sorter.

For the functioning details see user manual, **USER.MAN.REF.**

NOTE: For the connection of inputs and outputs, follow the electrical schemes at section "ELECTRICAL SCHEMES".

Part reserved for the Authorised Technical Personnel

3. SETUP ENVIRONMENT

By "SETUP environment" we mean a certain menu inside which all the indicator operating parameters can be set.

To enter it, turn on the instrument and, while the software version is displayed, press the TARE key for an instant.

Once in the set-up environment, the instrument displays the first step.

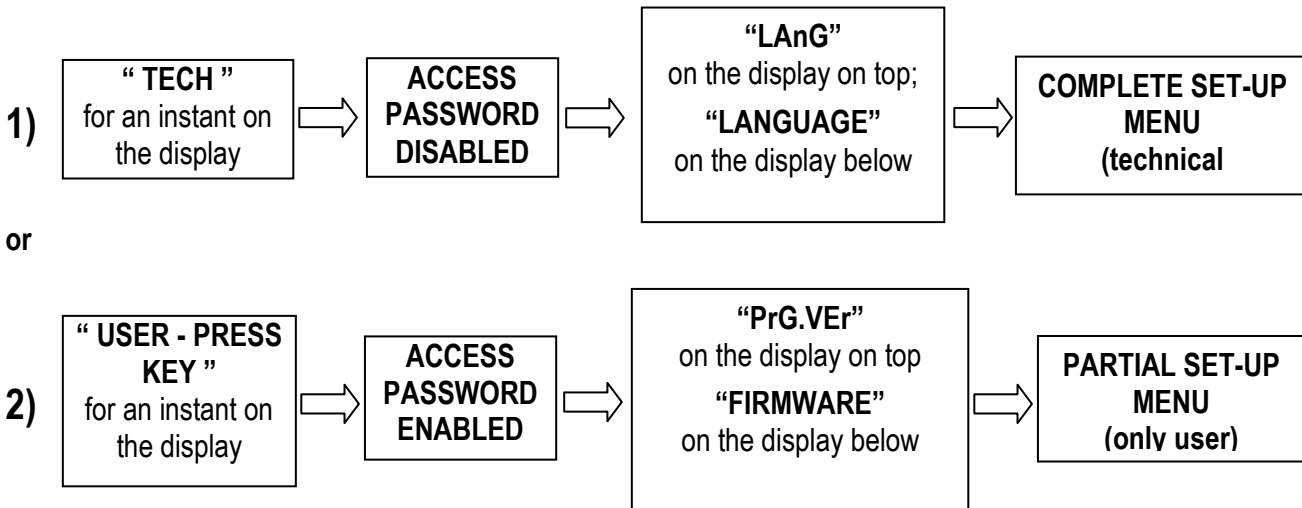

If you are in choice 2) and you want to access the complete set-up menu one should:

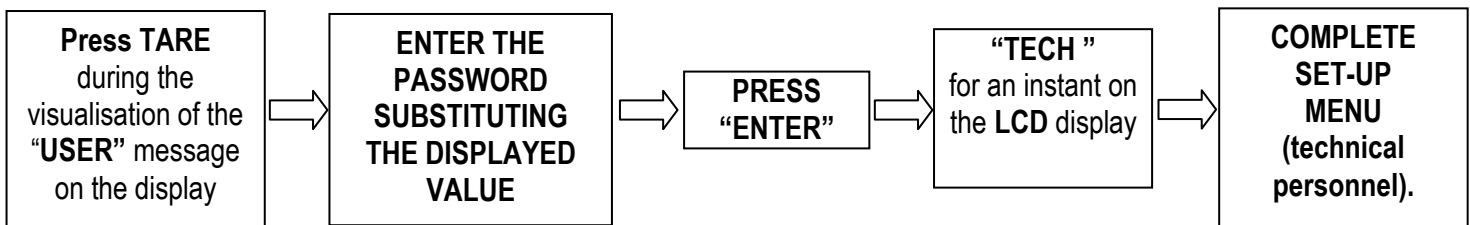

In the parameter description and in the block diagram

- The **METRIC** parameters are shown with the (*) symbol, and, with approved instrument, these may not be visible or read only. See the explanation of the parameter for the details.

NOTE: The indicator is approved when the J1 jumper of the motherboard is closed (see the electrical scheme in the final chapter).

- The **CONDITIONAL STEPS** are shown with the (§) symbol, and are not displayed in specific conditions, shown in the step description.
- The **DEFAULT VALUES** are shown with the (!) symbol placed next to the step and at the end of it.

FUNCTION OF THE KEYS IN THE SET-UP ENVIRONMENT

KEY	FUNCTION
F5	Allows to print the steps of the setup environment and the corresponding set values, and a heading with additional information about the instrument.
F6, F7	Allow to scroll forwards and backwards in the menu steps or in the parameters inside a step.
Fn / ENTER	Allows to enter a step or to confirm a parameter inside a step.
C / DEL	Allows to exit a step without confirming any changes made and to go to the previous level.
NUMERIC KEYBOARD	Allows entering an alphanumeric input.

The display show the current parameter and its description; generally, when one exits a step the instrument places itself on the following step.

TO EXIT THE SET-UP ENVIRONMENT, PRESS THE C KEY MANY TIMES UNTIL THE INDICATOR SHOWS:

**EXITING SETUP:
SAVE ?**

CONFIRM WITH ENTER TO SAVE CHANGES MADE OR PRESS ANOTHER KEY TO NOT SAVE.

PRINTOUT OF THE STEPS OF THE SETUP ENVIRONMENT AND SET VALUES

- If one is displaying the step "LANG", "F.Mode", "Setup" or "DiAG.": by pressing **F5**, the list of all the steps of the setup environment and the corresponding set values are printed.
- If one is displaying one step inside to those mentioned above: by pressing **F5**, the step displayed and the possible internal steps with the corresponding set values are printed.

In both cases these data are preceded by a heading that contains the name and the version of the installed software, the serial number of the instrument and a parameter that indicates if the default printouts are present (PRN .DFLT = YES) or not (PRN.DFLT = NO).

3.1 SET-UP ENVIRONMENT BLOCK DIAGRAM

The following diagram represents the structure of the indicator's set-up environment; each step has been described in detail in the following paragraph "DESCRIPTION OF THE STEPS".

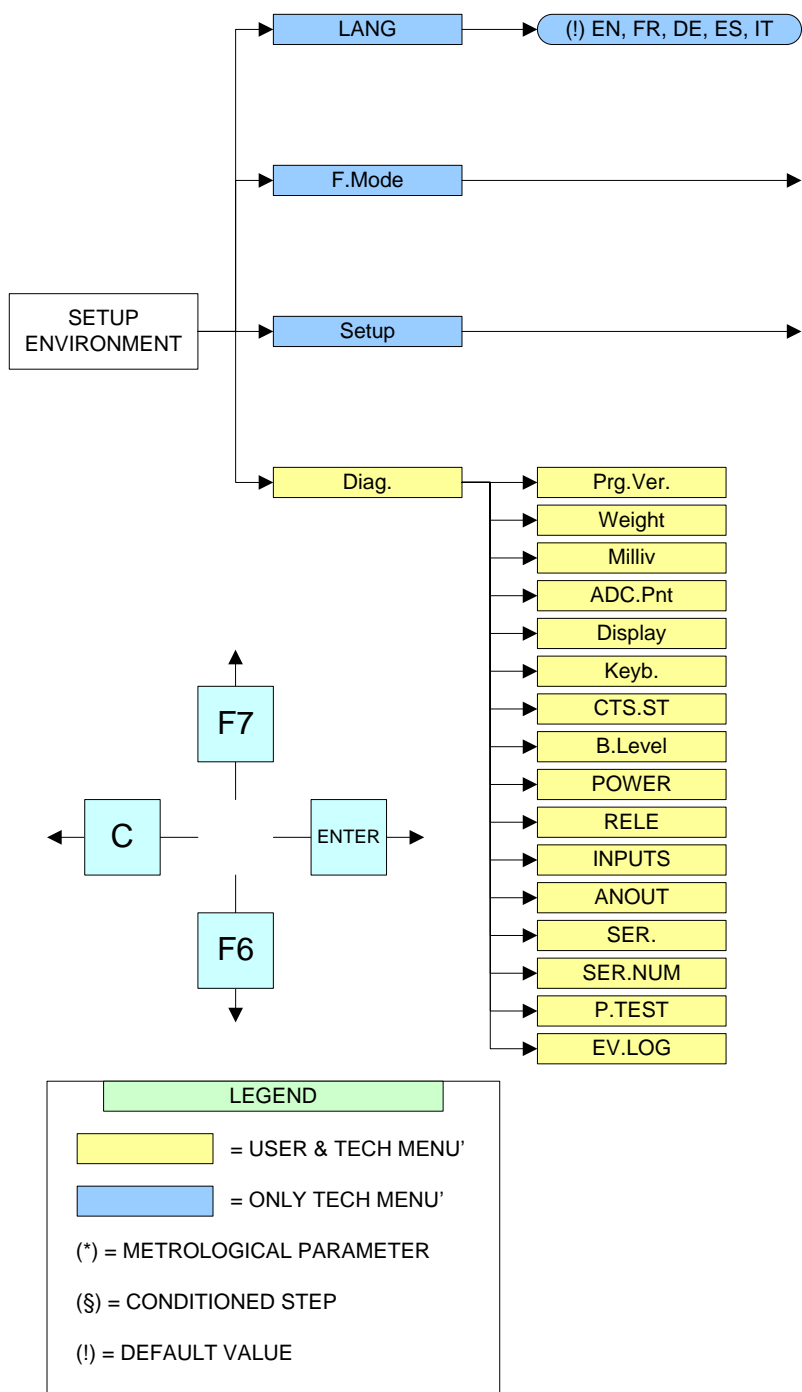

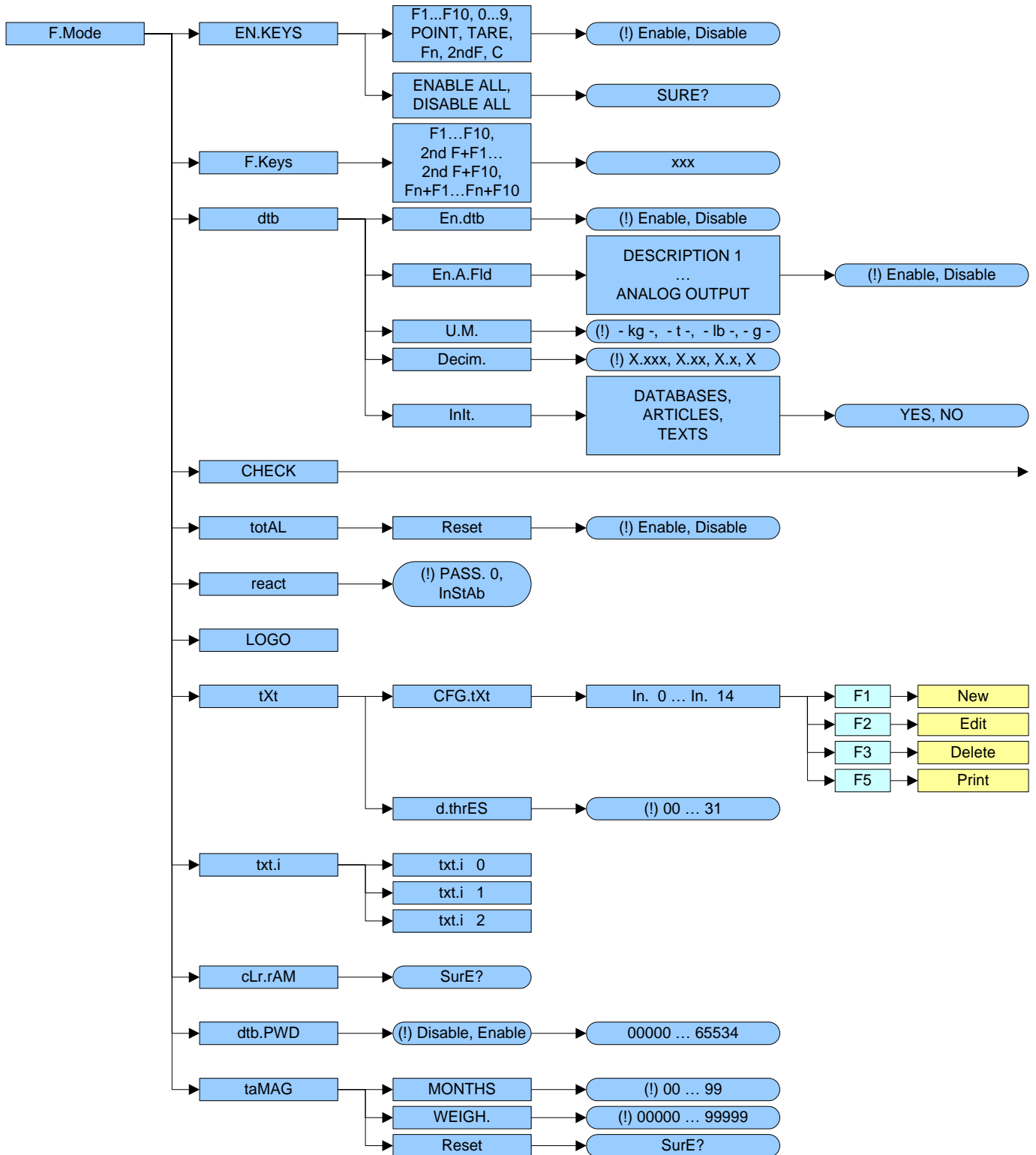

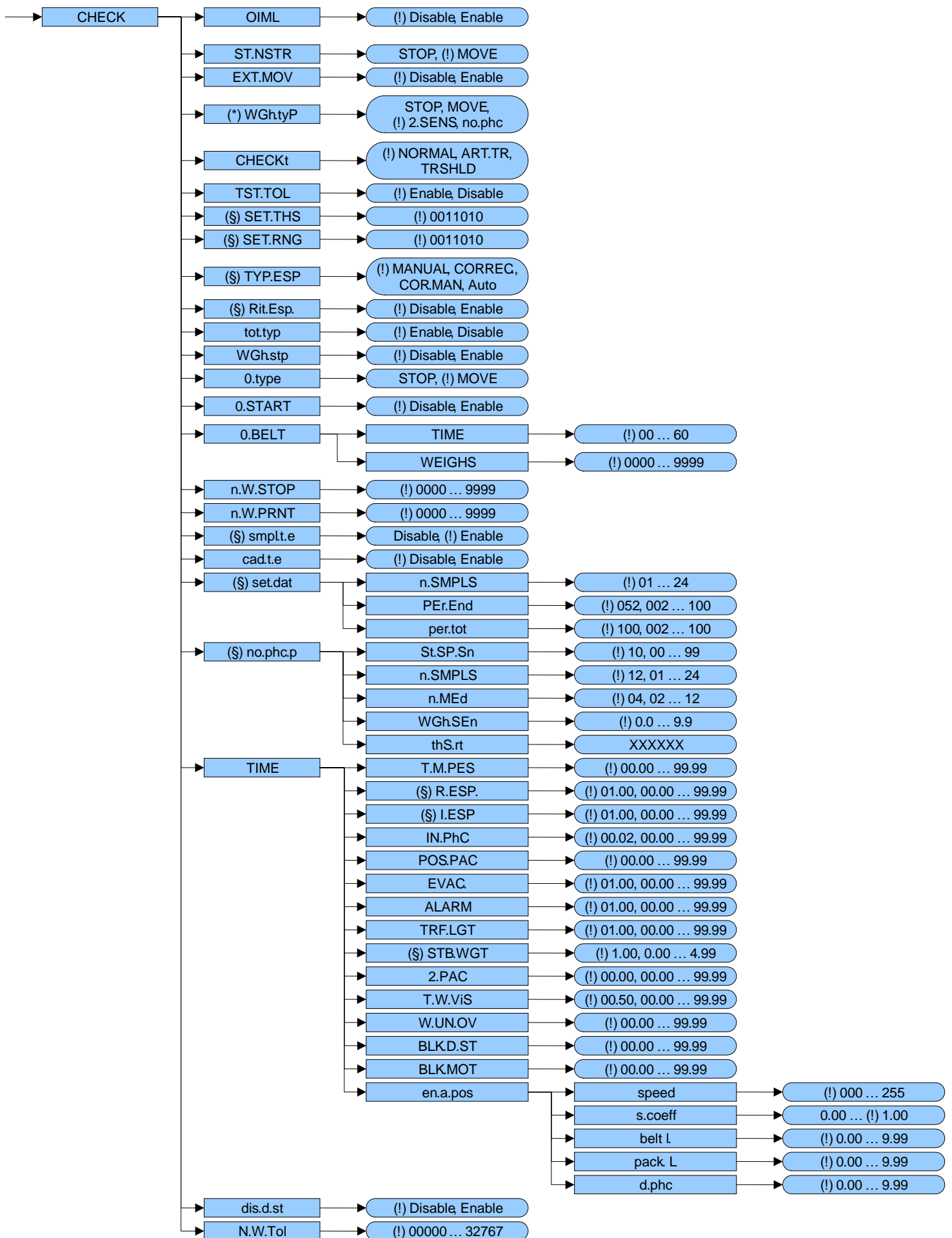

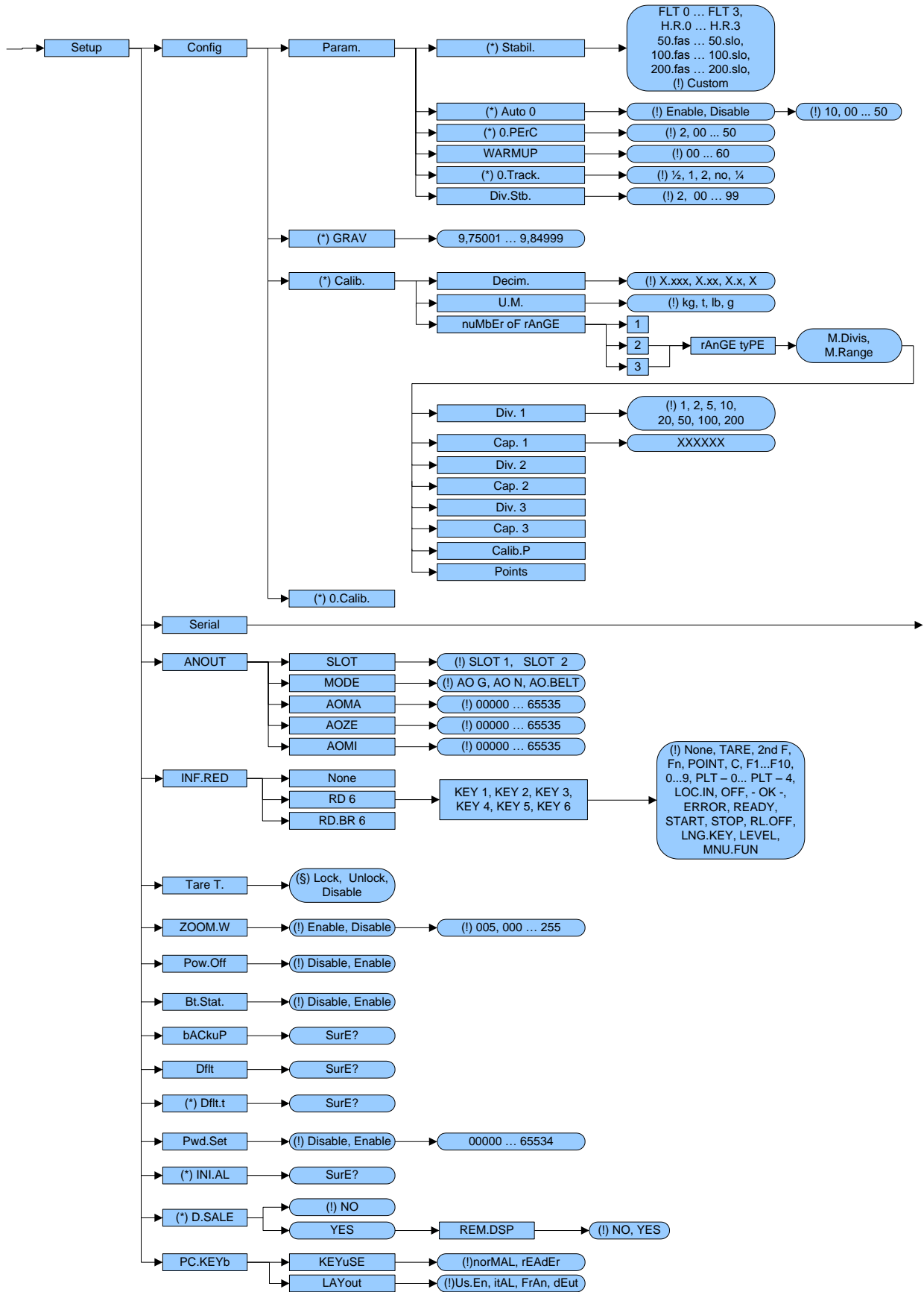

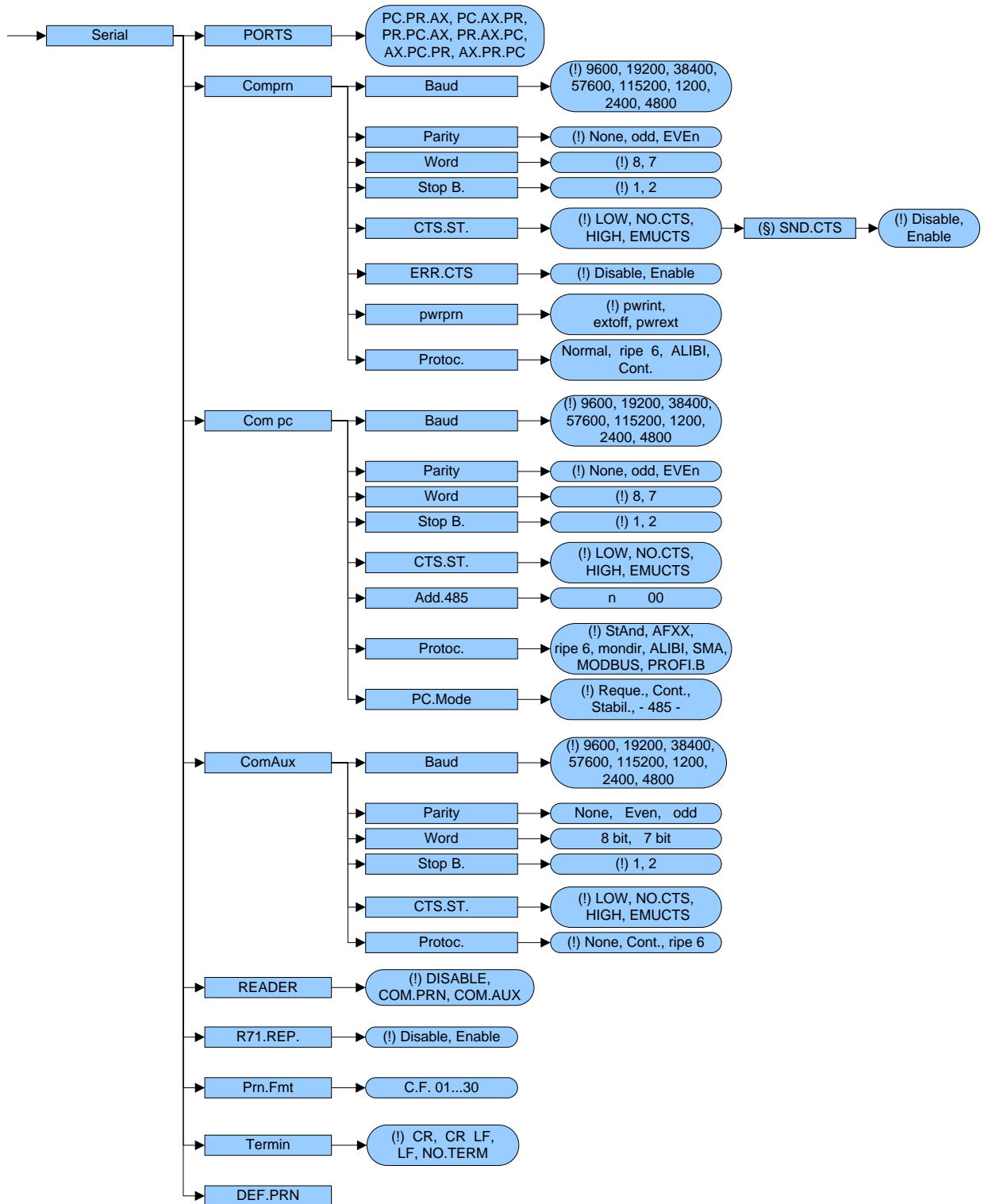

3.2 DESCRIPTION OF THE STEPS

<< LANG >> LANGUAGE SELECTION

- EN English
 - FR Français
 - DE Deutsch
 - ES Español
 - IT Italiano
- (!) EN

<< F.Mode >> SCALE FUNCTIONING

<< EN.KEYS >> KEYS ENABLING

It is possible to enable/disable each single key of the keyboard as well as the following two sequences of keys:

- Fn + Fn for access to a menu listing all functions
- 123 + Fn for direct access to a specific function (e.g. number 123)

- Press ENTER to modify the setting.



Key -----

State -----

- Press F6/F7 to select "Enable" (enabled) or "Disable" (disabled), and ENTER to confirm.



QUICK FUNCTION RECALL THROUGH 999 + 123 + Fn

If the function 123 + Fn is not enabled, it is possible to directly recall the desired function with the 999 + 123 + Fn keys' combination in weighing phase.

NOTES:

- It's possible to enable/disable all the keys together (including the above-mentioned sequences of keys), by selecting "ENABLE ALL" or "DISABLE ALL" (the confirmation will be requested with the message "SURE?").
 - The disabling of the keys will have effect only the WEIGHING PHASE, in other words, not inside the menus, databases, etc...
 - The turning off of the instrument (long pressing of the C key) will always be enabled.
 - The disabling of the keys will be applied also on the PC keyboard, if connected.
- (!) **ENABLE ALL, including the sequences of keys "Fn + Fn" and "123 + Fn"**

<< F.Keys >> FUNCTION KEYS COUPLING

It's possible to modify the function of the F1, F2....F10 keys, and the combination of these with the **2nd F** or **Fn** keys (i.e. "2nd F + F1", "Fn + F2", etc...).

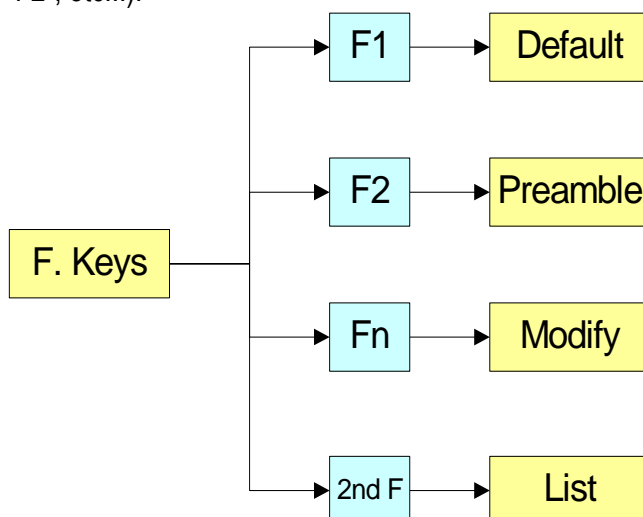
**KEYS' FUNCTIONS IN THIS STEP**

- F6(▲)** scrolls backward through the list keys.
F7(▼) Next in the list scrolls keys.
F1 ripristina l'accoppiamento dei tasti alle funzioni di default.
F2 restores the pair of keys to default settings.
ENTER change the code of the function assigned to the current key; when entering the confirmation code.
2nd F displays the list of functions; press ENTER to select the desired function. (see how in the next paragraph)

NOTE:

By pressing the **. /HELP** key, it's possible to display the list of the keys used inside this step and their functions. The list is automatically shown. If one wants to scroll the list of the keys in manual mode, it is possible to use the arrow keys (F6 ▼ and F7 ▲).

- Move with the keys F6 and F7, It scrolls up and down the list of keys and press "ENTER" (IMAGE 1):

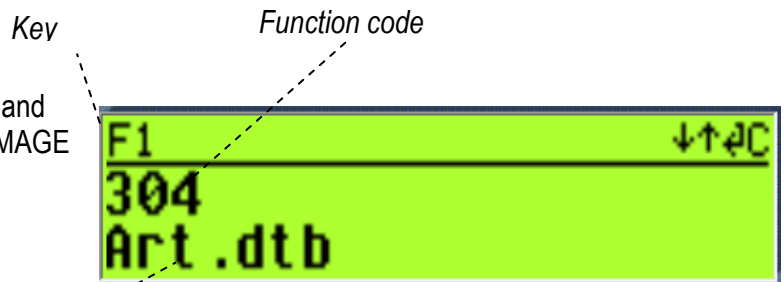

Function

IMAGE 1

- The list of functions associated with the key and confirmed that run in numerical order with the arrow keys (F6 ▼ e F7 ▲) is possible to go enter/modify its function. Press ENTER to change the power function.



IMAGE 2

N.B.: Pressing 2nd F instead it will shown the complete list of the functions with relative description.



IMAGE 3

- Press ENTER to modify the desired function. Enter the code for the desired function and confirm by pressing (IMAGE 3).



IMAGE 4

- Below you will find the list of all the functions with the relative codes.

CODE	BASIC FUNCTIONS	DEFAULT KEY/S
100	Scale zero (ZERO)	ZERO
101	Cyclic zero (0.CYCLE)	2ndF + ZERO
102	Tare execution (TARE)	TARE
103	Enable the printer (PRN-ON)	Fn + 0
104	Simple printout (PRINT)	F5
105	Repetition of last printout (CPY.PRN)	2ndF + F5
106	Change visualization weight (WEI.VIS)	2ndF + F8
107	Change LCD display visualization (LCD.VIS)	2ndF + F9
108	Lock/unlock keyboard (L.KEYB)	long pressing of F1
109	Visualization times ten (Disp.10)	long pressing of F2
110	Set time and date (CLOCK)	long pressing of F3
111	Diagnostics menu (Diag)	long pressing of F4
112	Lock/unlock tare (L.TARE)	long pressing of F5
113	Input text configuration (txt)	F4
114	Calculator (CALC)	
115	Print and clear partial total (Prn.0.t0)	F8
116	Print and clear general total (Prn.0.t1)	F9
117	Print and clear grand total (Prn.0.t2)	F10
118	Diagnostics peripheral units (P.DIAG)	
119	Com data diagnostics (COM.DAT)	
120	Customized display enabling or change of visualization if already enabled (CST.DSP)	Fn + F9
121	Input text 0 configuration (txt.0)	
122	Input text 1 configuration (txt.1)	
123	Input text 2 configuration (txt.2)	
124	Input text 3 configuration (txt.3)	
125	Input text 4 configuration (txt.4)	
126	Input text 5 configuration (txt.5)	
127	Input text 6 configuration (txt.6)	
128	Input text 7 configuration (txt.7)	
129	Input text 8 configuration (txt.8)	
130	Input text 9 configuration (txt.9)	
131	Input text cancellation: from 0 to 14, 99 erase all the texts (txt.rSt)	
132	Print format sending: from 0 to 30 (Send.P.F)	
OTHER FUNCTIONS		
200	Format linking to the Simple Printout (Prn.Fmt)	
201	Format Linking to the Totalisation (SND.FMT)	
208	Change visualization with enabled zoom (DAT.VIS) (only for CPWE)	
SPECIAL FUNCTIONS		
300	Visualization weight threshold values (WEI.TR)	
301	Set minimum threshold (tr.LO)	F2
302	Set maximum threshold (tr.HI)	F3
303	Print and clear lot total (Rpt)	2ndF + F3
304	Article database (Art.dtb)	F1
305	Print and clear article total (Prn.0.t3)	2ndF + F1
306	Article alphabetic search (SEL.ART)	

307	Visualization weigh report (V.rpt)	Fn + F3
PRINTOUT MENU VISUALIZATIONS		
400	Totaliser additional value (Add.VAL)	
401	Set progress digits (Prg.1)	
402	Set progress ticket (Prg.2)	
403	Visualizes partial total (V.t-0)	
404	Print partial total (Prn.t-0)	
405	Reset partial total (0.t-0)	
406	Visualizes general total (V.t-1)	
407	Print general total (Prn.t-1)	
408	Reset general total (0.t-1)	
409	Visualizes grand total (V.t-2)	
410	Print grand total (Prn.t-2)	
411	Reset grand total (0.t-2)	
412	Visualizes article total (V.t-3)	
413	Print article total (Prn.t-3)	
414	Reset article total (0.t-3)	
415	Reset scale totals (0.t-ALL)	
416	Print lot total (Rpt)	
417	Reset lot total (0.W.rpt)	
418	Reading aliby memory (ALIBI)	

Preamble function

It is possible to associate also a preamble (numeric value) to the F1, F2...F10 keys. In this way, when the key is pressed, the preamble is automatically used as parameter of the function to be executed.

The functions to which can be associated a preamble are:

FUNCTION	VALUE TO SET IN THE PREAMBLE
Change visualization LCD display (LCD.VIS)	Number of the desired visualization
Input text configuration (tXt)	Number of the input text that one wants to modify
Reset input texts (tXt.rSt)	Number of the input text that one wants to cancel
Send print format (Send.P.F)	Number of the print format that one wants to send
Coupling print formats (Prn.Fmt)	Number of the format on which one wants to modify the coupling
Set minimum threshold (tr.LO)	Minimum threshold
Set maximum threshold (tr.HI)	Maximum threshold
Article database (Art.dtb)	Number of the desired article.
Totaliser additional value (Add.VAL)	The desired additional value
Set progress digits (Prg.1)	Number of the desired digit
Set progress ticket (Prg.2)	Number of the desired ticket

- Moving with the F6 and F7 keys, you scroll up and down the list of keys and press "ENTER" (IMAGE 6):

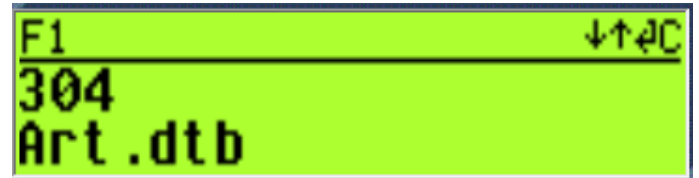

Function
IMAGE 5

- You see the list of functions associated with the key confirmato.e that run in numerical order with the arrow keys (F6 ▼ e F7 ▲) it is possible to go inserie / modify its function. Press ENTER to change the power function.



IMAGE 6

- Select parameter "Enable" with F6 and press "ENTER"

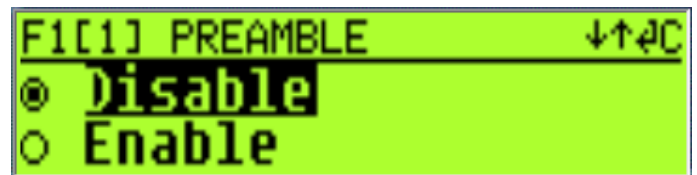

IMAGE 7

- Insert the preamble and press "ENTER"



Preamble value
IMAGE 8

N.B.: If you set the value 9999 as a preamble to a key combined with an archive function, pressing the button is deselected the active record.

Key (preamble + function)



IMAGE 9

<< dtb >> CONFIGURATION OF DATABASES**<< En.dtb >> ENABLING DATABASE**

It is possible to enable or disable the ARTICLE DATABASE:

Enable databases enabled.

Disable databases disabled.

(!) Enable

<< En.A.Fld >> ARTICLE FIELD ENABLING

It's possible to enable one by one the fields necessary for the application.



- Press F6/F7 to select "Enable" (enabled) or "Disable" (disabled), and ENTER to confirm.
- Proceed up to the last suggested field, after which it automatically exits the step.

NOTE: The first article description is always enabled.

<< U.M. >> DATABASE UNIT OF MEASURE

It is possible to set the unit of measure of the ARTICLE database; in relation to the total values: kg, t, lb, g; if the unit of measure is different than the one of the active scale, the displayed or printed total value will be automatically converted with the database's unit of measure.

(!) kg

<< Decim. >> DATABASE DECIMALS

It is possible to set the number of decimals of the ARTICLE database, in relation to the total values: 1, 2, 3, no decimal; if the number of decimals is less than the one of the active scale, the displayed or printed total value will be automatically rounded off.

(!) x.xxx

NOTE: unit of measure and decimals of the database must be set as those those of calibration.

<< Inlt. >> INITIALIZE DATABASE and INPUT TEXTS

By pressing **ENTER** one initialises the ARTICLE DATABASE (with the total values) and the INPUT TEXTS: in this way all their contents will be cancelled.

The cancellation is not immediate; the indicator requests a further confirmation (the LCD display shows "RESET DATABASES ? ENTER=YES C=NO"). By pressing **ENTER** one confirms the operation, by pressing **C**, the indicator gives the possibility **to cancel all the databases individually** in this order: ARTICLE DATABASE, INPUT TEXTS.

<< CHECK >> BELT AND CHECK FUNCTIONING**<< OIML R 51 >> NUOVO PARAMETRO CHE MODIFICA L'ALIBI MEMORY**

Enabling this parameter, it sets protocol alibi memory on the printer port and saves any totalized.

(!) Disable

(*) When the instrument is approved, this parameter cannot be changed.

<< ST.NSTR >> BELT STATUS UPON THE START-UP OF THE SYSTEM

STOP stopped belts; one should enable the belts (OUT1 and OUT2) giving a RESTART impulse (IN4).

MovE belts in motion.

(!) MovE

<< EXT.MOV >>

If enabled, once the march (IN1) stops accidentally in weighing, allows once reactivated to go ahead without the need to restart (IN4). Used in automation if there is a natural person who can keep up with the machine.

(!) Disable

<< (*) Wgh.tyP >> TYPE OF WEIGH

STOP weigh upon stopped belt

2.SENS two-sensor weigh

MOVE weigh in motion

no.phc weigh without photo cell

See user manual for further information.

(!) 2.SENS NOTE: with 2 photocells, weighing improves with packs of length less than the pack longer.

(*) In case of approved instrument the parameter is read only.

<< CHECK.t >> SELECTING TYPE OF CHECK

Here one selects the type of check which one wants to make:

NORMAL With article and setting of the tolerance thresholds (T1, T2, T3);

ART.TR With article and setting of minimum and maximum threshold;

TRSHLD Without article and setting of minimum and maximum threshold.

(!) NORMAL

<< TST.TOL >> ENABLING THE TOLERANCE TEST FUNCTION

Enable enabled tolerance test.

The tolerance test provides for, in this order:

- The tolerance test in respect to a set range.
- The storage of the weigh and data processing (only if the totalisation within tolerance is enabled in the << tot.tYP >> step).
- The management of the tolerance indication outputs or of the alarm and expulsion outputs if the weight is out of tolerance.

Disable disabled tolerance test.

Refer to the user manual for further information.

(!) Enable

<< (\$) SET.THS >> SELECTING THE THRESHOLDS FOR ENABLING THE OUT5 - OUT11 OUTPUTS

The instrument offers the possibility of enabling /disabling weight range indication outputs; the LCD display shows:



Each numeric value (0 or 1) corresponds to the enabling of a threshold indicator outputs :

0	0	0	1	0	0	0
OUT6	OUT7	OUT8	OUT5	OUT9	OUT10	OUT11

To enable a control output, one should switch the 0 into 1, using the F7 key; to disable it, one should switch a 1 into 0, by pressing the F6 key.

To scroll the various outputs press the F8 or F9 keys.

Once enabled, the outputs are enabled according to the following conditions:

	TARGET - t3	TARGET - t2	TARGET - t1	TARGET	TARGET + t1	TARGET + t2	TARGET + t3	
OUT11: $(\text{Target} + t3) < \text{Weigh}$	OFF	OFF	OFF	OFF	OFF	OFF	OFF	ON
OUT10: $(\text{Target} + t2) < \text{Weigh} \leq (\text{Target} + t3)$	OFF	OFF	OFF	OFF	OFF	OFF	ON	OFF
OUT9: $(\text{Target} + t1) < \text{Weigh} \leq (\text{Target} + t2)$	OFF	OFF	OFF	OFF	OFF	ON	OFF	OFF
OUT5: $(\text{Target} - t1) \leq \text{Weigh} \leq (\text{Target} + t1)$	OFF	OFF	OFF	ON	ON	OFF	OFF	OFF
OUT8: $(\text{Target} - t2) \leq \text{Weigh} < (\text{Target} - t1)$	OFF	OFF	ON	OFF	OFF	OFF	OFF	OFF
OUT7: $(\text{Target} - t3) \leq \text{Weigh} < (\text{Target} - t2)$	OFF	ON	OFF	OFF	OFF	OFF	OFF	OFF
OUT6: $\text{Weigh} < (\text{Target} - t3)$	ON	OFF	OFF	OFF	OFF	OFF	OFF	OFF

EXAMPLES

	0	0	1	1	1	0	0
	OUT6	OUT7	OUT8	OUT5	OUT9	OUT10	OUT11

This configuration enables OUT8 if the weight is $< (\text{Target} - t1)$, OUT5 if the weight is between $(\text{target} - t1)$ and $(\text{target} + t1)$, OUT9 if the weight is $> (\text{Target} + t1)$.

	1	1	1	1	1	1	1
	OUT6	OUT7	OUT8	OUT5	OUT9	OUT10	OUT11

This configuration enables OUT6 if the weight is $< (\text{Target} - t3)$, OUT7 if the weight is $< (\text{Target} - t2)$, OUT8 if the weight is $< (\text{Target} - t1)$, OUT5 if the weight is between $(\text{target} - t1)$ and $(\text{target} + t1)$, OUT9 if the weight is $> (\text{Target} + t1)$, OUT10 if the weight is $> (\text{Target} + t2)$, OUT11 if the weight is $> (\text{Target} + t3)$.

The instrument activates only the enabled outputs; furthermore the instrument enables a single indication output with each weigh.

The check always starts from the most external thresholds (TARGET - t3; TARGET + t3) and goes toward the target. As soon as a condition has taken place, the relative output is enabled and the check ends; the remaining thresholds are not checked.

NOTE: it's not possible to modify the status of the target outputs (therefore OUT5 is always enabled)

- The programming of this step is irrelevant if operation is selected to minimum and maximum thresholds.

(!) 0011010

(§) Accessible only if the tolerance test is enabled ($\ll \text{TST.TOL} \gg$ step)

<< (§) SET.RNG >> SELECTING THE THRESHOLDS FOR CALCULATING THE TOLERANCE RANGE

The instrument offers the possibility of configuring the tolerance range which, in the weighing phase, discriminates whether the weigh is within tolerance or not. The LCD display shows:



Each numeric value (0 or 1) corresponds to the enabling of a threshold ; Only the extremities of the tolerance range should be enabled:

EXAMPLES

	0	0	0	1	0	0	0
TARGET - t3							
TARGET - t2							
TARGET - t1							
TARGET							
TARGET + t1							
TARGET + t2							
TARGET + t3							

To enable a check threshold, one should switch the 0 into 1 using the F7 key; to disable it, one should switch a 1 into 0, by pressing the F6 key.

To scroll the various thresholds, press the F8 or F9.

EXAMPLES (1)

	0	0	1	1	1	0	0
TARGET - t3							
TARGET - t2							
TARGET - t1							
TARGET							
TARGET + t1							
TARGET + t2							
TARGET + t3							

This configuration determines a tolerance range between TARGET - t1 and TARGET + t1

(2)

	0	1	0	1	1	0	0
TARGET - t3							
TARGET - t2							
TARGET - t1							
TARGET							
TARGET + t1							
TARGET + t2							
TARGET + t3							

This configuration determines a tolerance range between TARGET - t2 and TARGET + t1

(3)

	0	0	1	1	0	0	0
TARGET - t3							
TARGET - t2							
TARGET - t1							
TARGET							
TARGET + t1							
TARGET + t2							
TARGET + t3							

With this configuration setting T1 = 0 then the minimum weight of the weight range ok becomes the target, with this program you will only see in print weigh below T1 and weighed ok.

(4)

	0	0	1	1	1	1	0
TARGET - t3							
TARGET - t2							
TARGET - t1							
TARGET							
TARGET + t1							
TARGET + t2							
TARGET + t3							

With this configuration, the indicator sets as the upper limit threshold T1 +, the indicator also calculates the weighted above + T2, however, all items above + T1 are considered out of tolerance and then expelled.

NOTE:

- it's not possible to modify the status of the target threshold; furthermore, the target is not considered as a tolerance threshold.
- the tolerance range determines the activation of the OUT4 expeller output.
- The programming of this step is irrelevant if operation is selected to minimum and maximum thresholds.

(!) 0011010**(§)** Modifiable only if the tolerance test is enabled (<< **TST.TOL** >> step).**<< (§) TYP.ESP >> TYPE OF EXPULSION****Auto** automatic expulsion (management of OUT4)**MANUAL** manual expulsion**CORREC.** Manual correction with correction of weight.**COR.MAN** Manual correction with correction compulsory weighed out of tolerance.**(!) MANUAL****(§)** Accessible only if the tolerance test is selected (<< **TST.TOL** >> step).**<< (§) Rit.Esp. >> SELECTION OF THE EXPULSION DELAY FROM ARTICLE**

It is possible to decide whether to use the expulsion delay time set in the << **R.ESP.** >> step, for all the articles selectable from the database, or use the expulsion time entered when compiling the database (section "ENTRY", **USER MAN.REF.**) different for each article selectable from the database.

Enable use of the expulsion delay time configured in the selected article.**Disable** use of the expulsion delay time configured in the << **R.ESP.** >> setp independently from the one configured in the selected article.**(!) Disable****(§)** Accessible only if the tolerance test (<< **TST.TOL** >> step) is selected and the compulsory correction of the out of tolerance weighs (<< **TYP.ESP** >> step) is not selected.**<< (§) tot.tyP >> TOTALISATION OF JUST THE WEIGHS WITHIN TOLERANCE**

With the tolerance test enabled, it is possible to choose whether to totalise just the weighs within tolerance or all the executed weighs. See section "TOTALIZATION OF ONLY THE WEIGHS WITHIN TOLERANCE" (**USER MAN.REF.**) for further information.

Disable totalisation of all the weighs**Enable** totalisation of just the weighs within tolerance**NOTE:** independently from the configured value, the instrument's LCD display will show the result of each weigh either with the weight within tolerance as well as the weight out of tolerance.**(!) Enable****(§)** Accessible only if the tolerance test has been selected (<< **TST.TOL** >> step)**<< (*) Wgh.stp >> STOP AFTER WEIGHING**

Once the weigh is made, independently of the obtained result, the instrument stops the weighing belt and waits for a RESTART impulse (IN4) in order to restart.

Enable enabled stop**Disable** not enabled stop**(!) Disable****(*)** In case of approved instrument the parameter is read only.**<< 0.type >> TYPE OF AUTOMATIC ZERO OF THE WEIGHING BELT****STOP** automatic zero from still position**MOVE** automatic zero in motionSee section "WEIGHING BELT AUTOZERO" (**USER MAN.REF.**) for further information.**(!) MOVE**

<< 0.START >> ENABLING THE AUTOMATIC ZERO UPON THE RESTART OF THE WEIGHING BELT**Disable** disabled automatic zero**Enable** enabled automatic zeroSee section "WEIGHING BELT AUTOZERO" (**USER MAN.REF.**) for further information.**(!) Disable****<< 0.BELT >> BELT AUTOMATIC ZERO****TIME:** automatic zero at time

Enter the number of minutes after which the automatic zero function will activate automatically.

The settable values go from 0 to 60:

- by setting a value greater than 0 the function is automatically executed each time that the configured number of minutes is elapsed.
- by setting 0, the function is disabled.

WEIGHS: automatic zero at weighs

Enter the number of executed weighs after which the automatic zero function will activate automatically:

The settable values go from 0 to 9999.

- By setting a value greater than 1, the function is automatically executed each time that the configured number of weighs is reached.
- By setting the value 1, after each weigh the instrument waits for the "PACK EVACUATION" time and at the end automatically executes the function if the weight is other than 0 and the instrument is in "WAIT FOR PACK".
- By setting 0, the function is disabled.

See section "WEIGHING BELT AUTOZERO" (**USER MAN.REF.**) for further information**(!) TIME, 00****<< n.W.STOP >> NUMBER OF OUT OF TOLERANCE WEIGHS PER BELT STOP**Set the number of executed out of tolerance weighs after which the indicator stops the weighing belt (OUT2) and enables the general alarm output (OUT3) for the time set in the **<< ALARM >>** step.

To reenable the weighing belt (and the eventual cadence belt stopped due to the pack presence), one should supply a restart impulse (IN4).

The settable values are from 0 to 9999; by entering the 0 value the function is disabled.

See section "STOP OF BELTS AFTER A NUMBER OF WEIGHS OUT OF TOLERANCE" (**USER MAN.REF.**) for further information.**(!) 0000****<< n.W.PRNT >> SETTING NUMBER OF WEIGHS FOR AUTOMATIC RESETTING OF PARTIAL TOTAL**

Set the number of weighs after which the partial total will be printed and automatically reset

The settable values are from 0 to 9999; by entering the 0 value the function is disabled.

(!) 0000**<< (§) smp1.t.e >> WEIGH START ON THE FALLING EDGE OF THE WEIGH START PHOTO CELL**

This step allows to enable the weight acquisition following the falling edge of the weigh START photo cell. When the package engages the weigh start photo cell, the instrument will then wait for the falling edge of the photo cell, which is given once the package has advanced beyond the photo cell; after this, the package positioning and weigh time is enabled.

NOTE: in 2 sensor weight time, the weigh stop is in any case supplied by the leading edge of the STOP photo cell.**Disable** positioning time start on the leading edge**Enable** positioning time start on the falling edge**(!) Enable****(§)** Accessible only in the functioning modes with photo cell

<< cad.t.e >> CADENCE TIME START ON THE FALLING EDGE OF THE CADENCE PHOTO CELL

This step allows to enable the cadence time following the falling edge of the CADENCE photo cell. When the package engages the cadence photo cell, the instrument will then wait for the falling edge of the photo cell, which is given once the package has advanced beyond the photo cell; after this, the cadence time is enabled.

NOTE: The cadence belt stop (depending on step << 2.PAC >>) is in any case supplied by the leading edge of the CADENCE photo cell, independently from what is configured in this step.

Disable cadence time start on the leading edge

Enable cadence time start on the falling edge

(!) Disable

<< (§) set.dat >> SETTING THE PARAMETERS FOR WEIGH IN MOTION AND WITH TWO SENSORS

(§) Accessible only if the weigh in motion or with two sensors has been selected (<< WGH.tyP >> step)

<<n.SMPLS>> NUMBER OF SAMPLES FOR CALCULATING A WEIGHT DATUM

Set the number of samples which will be averaged in order to get a weight datum.

The settable values are from 1 to 24.

Set a low value (like 1, 2, 3 or 4) if the weight is stable or a high weighing speed is requested; one can increase this value (like from 6 to 12) if the weight shows to be unstable, improving in this way, the weigh accuracy.

If the weight shows to be too unstable, increase the value up to 24, to the disadvantage of the weigh calculation speed.

The acquisition time of each sample, depends on the filter sampling frequency which is set: if, for example, a filter with a 25Hz sampling frequency (25 samples per second, ES.FLT.3) has been set, and in this step 12 has been set, it will take half a second in order to have 12 samples.

(!) 01

<< PEr.End >> FINAL WEIGHT DATA PERCENTAGE

Enter the percentage of the calculated weight data by the instrument to be used to calculate the weigh.

Once the weigh time has passed (with the dynamic weigh) or after the weigh end photo cell is obscured (with the two-sensor weigh), the instrument will assess the percentage of the acquired data, specified in this step, starting from the end of the weigh.

EXAMPLE:

The weight is unstable at the beginning of the weigh and tends to stabilize towards half the weigh.

By setting 50 in this step, the instrument will process 50% of the acquired data during the weigh, starting from the end:

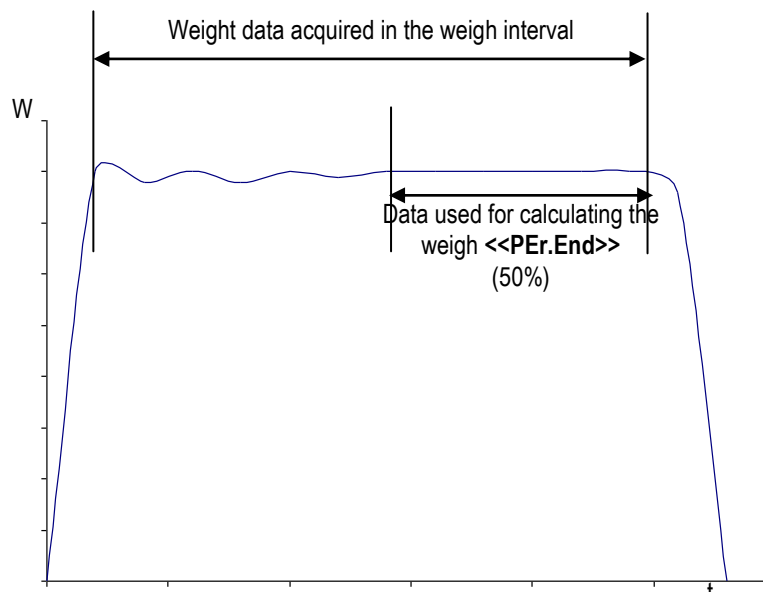

The settable values are from 2 to 100.

(!) 052

<< per.tot >> TOTAL DATA PERCENTAGE

The weight data determined by the percentage set in the previous step is ordered and only the best percentage set in this step is taken into consideration.

The settable values are from 2 to 100.

(!) 100

<< (\$) no.phc.p >> WEIGH WITHOUT PHOTO CELL PARAMETERS

(S) Accessible only if the weigh in motion or with two sensors has been selected (<< WGH.tyP >> step)

<<St.Sp.Sn>> SENSITIVITY FOR WEIGH START/STOP

Set the increment/decrement of the minimum weight for the detection of the leading edge and falling edge of the weight, necessary for determining the beginning and the end of the data acquisition.

The acquisition of the data begins, during the weight leading edge, when the instrument detects three consecutive weight values which determine an average difference (among those of each value from the previous one) which is greater than the configured value, and, ends when, during the trailing edge, the instrument detects three consecutive weight values which have an average difference (among those of each value from the previous one) greater than the negative value than the one set.

The value is always expressed in division 1, independently from the scale division; if, for example, the scale division is 5 g and the minimum difference must be 10 g, one should set 10 in this step.

The enabling and the reenabling of the weigh, are in any case, subject to the check of the minimum weigh threshold (set in the <<thS.rt>> step): the check on the stability for the weigh start/stop, starts after the weight has surpassed the set minimum threshold.

The settable values are from 0 to 99.

(!) 10

<<n.SMPLS>> NUMBER OF SAMPLES FOR CALCULATING A WEIGHT DATUM

Set the number of samples which will be averaged in order to get a weight datum.

The settable values are from 1 to 24.

Set a low value (like 8, 10 or 12) if the weight is stable or a high weighing speed is requested; one can increase this value (like 16, 15) if the weight shows to be stable, improving in this way, the weigh accuracy.

The acquisition time of each sample, depends on the filter sampling frequency which is set: if, for example, a filter with a 25Hz sampling frequency (25 samples per second, ES.Flt.3) has been set, and in this step 12 has been set, it will take half a second in order to have 12 samples.

In any case the instrument calculates the weight data also when the number of already acquired samples is less than this value.

(!) 12

<<n.MEd>> NUMBER OF AVERAGES FOR WEIGH CALCULATION

Set the number of consecutive weight values taken into consideration in order to obtain the best weigh: once the data acquisition is ended, the weigh is obtained by mediating the n consecutive weight values (set in this step) which have the lowest average difference (among those of each value from the previous one).

The settable values are from 2 to 12.

Set low values (i.e. 4) if the weight is unstable or if a high weighing speed is requested.

It is possible to set higher values (i.e. 8) if the weight is stable, improving the weigh accuracy;

(!) 04

<<WGH.SEn>> SENSITIVITY FOR WEIGH CALCULATION

Set the maximum weight variation required for detecting the weight stability in order to determine the anticipated end of the data acquisition before the pack evacuation, and therefore, determine the best weigh.

The settable values go from 0,1 to 9,9.

If one sets a value other than zero, the data acquisition ends when the instrument detects n consecutive weight values (set in step <<n.MEd>>) having an average difference (among those of each value different from the previous one) which is between the set value and its corresponding negative one.

Greater the weight is unstable, and higher must be this value; Greater the weight is stable and lower must be this value;

If this value is set at zero, the instrument will give the weight only when the pack evacuates, when the instrument detects a weight decrease greater than the value set in the <<St.Sp.Sn>> step (advised for applications with a belt in motion).

The value is always expressed in division 1, independently from the scale division; if, for example, the scale division is 5 g and the minimum difference must be 1 g, one should set 1.0 in this step.

(!) 0.0

<<thS.rt>> SETTING WEIGH ENABLING, DISABLING AND REENABLING THRESHOLD

Minimum threshold which the weight must surpass in order to enable the weigh start check; the same threshold ends the weigh (if not yet ended) and reenables the instrument for the following weighs, after the weigh has gone below it.

This threshold must always be less than the target, considering also the sensitivity for the weigh start/stop.

By setting the value 0, the weigh reenables with the passage of zero.

(!) 0.000

The graph below represents a hypothetic weight tendency during a weigh; the weight increases with a certain inclination tends to stabilise and then descends in the weight unloading phase.

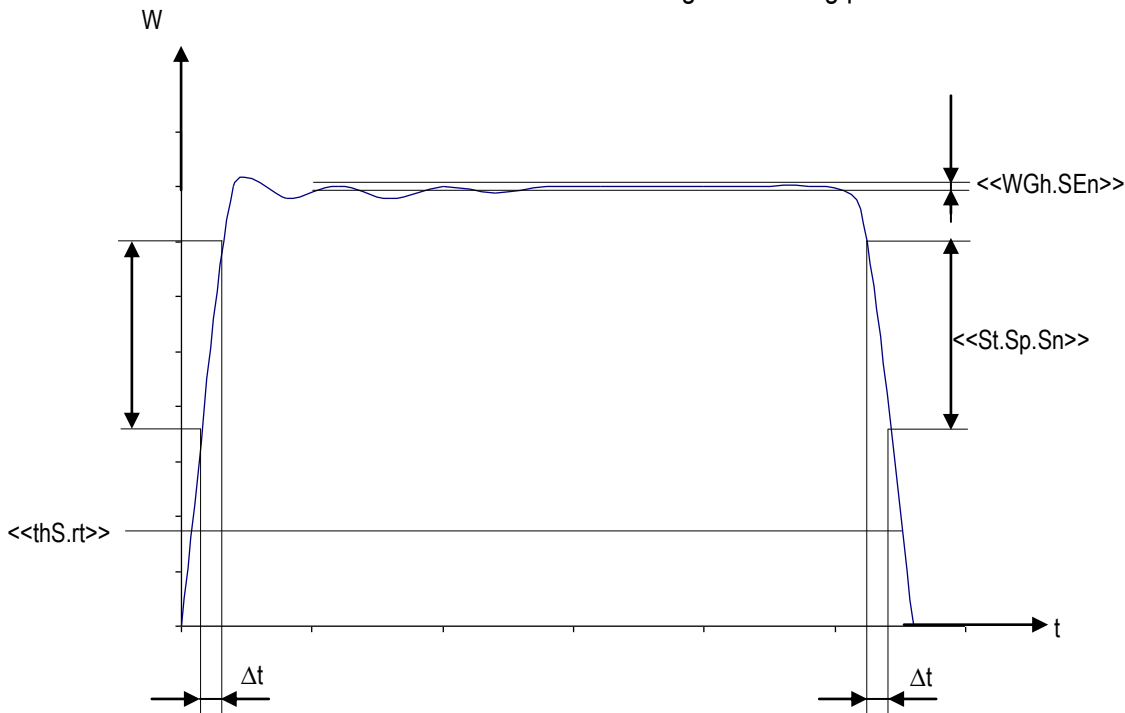

In the weigh without sensor, the steps described previously must be programmed, in order to obtain the correct weigh in the desired time.

In the graph:

Δt

It's the time period in which there must be a average difference > than <<St.Sp.Sn>> in order to start acquiring the weigh

$$\Delta t = (1 / \text{set filter frequency}) \times 3.$$

If this condition is not respected, the weigh will not start.

<<thS.rt>>

It's the weigh minimum threshold; this threshold is linked to the weigh start, to the weigh stop and to the weigh reenabling.

<<WGh.SEn>>

It's the maximum average difference which can have n weight values (configured in step <<n.MEd>>) in order to end early the weight acquisition before the evacuation and therefore determine the best weigh.

<< TIME >> SETTING THE TIME PERIODS OF THE INSTRUMENT**<< (§) T.M.PES >> TIME FOR WEIGHS (in seconds)**

(§) Accessible if the weigh with 2 sensors (<< **WGh.tyP** >> step) is not selected

Takes on different meanings depending on the selected weigh type (step << **WGh.tyP** >>):

- Weigh with stopped belt: once the pack positioning time has passed, it defines a maximum time duration of the weight instability condition after which the error condition is enabled; if, during this time, the weight is stable, it is zeroed and restarts each time that the weight becomes unstable.
The 0 value disables the function.
- Weigh in motion with 1 photo cell: Once the pack positioning time has passed, only in dynamic weighing, the instrument samples the weight for the duration of this time, obtaining the final weigh.
- Weigh without photo cell: it defines the maximum duration of the weigh calculation, starting from its enabling; at the end of this time, if other conditions have not taken place which determine the end of the weigh, the instrument ends the weigh totalising the value calculated up until that moment.

The settable values go from 0,00 to 99,99.

(!) 01.00

<< (§) R.ESP. >> EXPULSION OUTPUT ACTIVATION DELAY PERIOD (OUT4) (in seconds)

(§) Accessible only if the tolerance test (<< **TST.TOL** >> step) is selected and the compulsory correction of the out of tolerance weighs (<< **TYP.ESP** >> step) is not selected.

Time which passes from the instant the pack evacuation begins till the closing of the expulsion output (OUT4).

The settable values go from 0,00 to 99,99.

(!) 01.00

<< (§) I.ESP >> EXPULSION IMPULSE DURATION (in seconds)

(§) Accessible only if the tolerance test (<< **TST.TOL** >> step) is selected and the compulsory correction of the out of tolerance weighs (<< **TYP.ESP** >> step) is not selected.

Once the expulsion relay activation delay period has passed, the expulsion output (OUT4) is enabled for the time set in this step.

The settable values go from 0,00 to 99,99.

(!) 01.00

<< IN.PhC >> PHOTO CELL IMPULSE DURATION (in seconds)

Minimum duration of the impulse coming from the photo cells in order for this to be considered valid by the instrument.

The value 0 disables the function (the impulse is immediately considered).

The settable values go from 0,00 to 99,99.

(!) 00.02

<< PoS.PAC >> PACK POSITIONING TIME (in seconds)

Time which passes from when the pack obscures the photo cell on the weighing belt to when the pack is completely on the scale, ready to be weighed. Once the pack positioning time has passed, as soon as the weight becomes stable, the instrument starts to calculate the weight of the box.

The settable values go from 0,00 to 99,99.

(!) 00.00

<< EVAC. >> EVACUATION TIME OF THE PACK (in seconds)

This parameter allows to establish the time which the pack takes to completely leave the belt, useful, for example to execute the auto zero with an unloaded belt.

The 0 value disables the function.

The settable values go from 0,00 to 99,99.

(!) 01.00

<< ALARM >> IMPULSE DURATION OF THE GENERAL ALARM (OUT3) (in seconds)

Each time that there is an error condition in the weighing phase, the OUT3 output is enabled for the time set in this step.

The settable values go from 0,00 to 99,99.

By setting the alarm time equal to 0.00, the alarm will remain active until the error condition has ended or a restart impulse is given.

(!) 01.00

<< TRF.LGT >> DURATION OF ENABLING FOR THE TOLERANCE OUTPUTS (OUT5 – OUT1) (in seconds)

Once the weigh is made, it is possible to take advantage of the threshold outputs in order to crosscheck the executed weigh (out of tolerance or within tolerance, under the TARGET – T2, TARGET + T1 thresholds...).

These outputs will be enabled for the time set in this step.

The settable values go from 0,00 to 99,99.

(!) 01.00

<< (§) STB.WGT >> STABILITY TIME FOR WEIGH ACQUISITION (in seconds)

(§) Accessible only if the stopped belt weigh is selected (<< **WGh.tyP** >> step)

Once the package is positioned, this is the necessary time required for the weight stability condition in order to acquire the weigh; if during this time, the weight is unstable, it will be zeroed and will restart each time that the weight returns stable.

The settable values go from 0,00 to 4,99.

(!) 01.00

<< 2.PAC >> DELAY TIME BETWEEN TWO PACKS (in seconds)

Time which adjusts the cadence of the packs which arrive onto the weighing belt.

The settable values go from 0,00 to 99,99.

See section "MANAGEMENT OF CADENCE PHOTOCELL AND BELT" (**USER MAN.REF.**) for further information.

(!) 00.00

<< T.W.VIS >> WEIGH VISUALISATION TIME (in seconds)

Upon each weigh acquisition, the instrument's display shows the acquired weight and the progressive number of the executed weighs.

In this step one adjusts the time period of these visualisations.

The settable values go from 0,00 to 99,99.

The value 0 disables the function.

(!) 00.50

<< W.UN.OV >> MAXIMUM TIME OF weight UNDERLOAD / OVERLOAD CONDITION (in seconds)

Minimum time duration of the weight UNDERLOAD / OVERLOAD condition in order for it to be considered valid by the instrument in order to enable the alarm condition for weight in UNDERLOAD / OVERLOAD, end the weigh cycle and stop the belts.

In order to reenab the cycle it will be necessary to restore the weight and supply an impulse on the RESTART input (IN.E.2).

The settable values go from 0,00 to 99,99.

The 0 value disables the function.

(!) 00.00

<< (§) BLK.D.ST >> LOCK DELAY FROM DOWNSTREAM (IN6) (in seconds)

(§) Accessible only if the consensus from downstream is not excluded (step << **diS.d.st** >>) and if the external handling is not selected (step << **EXT.MOV** >>)

Minimum duration for disabling the consensus from downstream (IN6) in order for it to be considered valid in order to end the weighing cycle and stop the belts.

The settable values go from 0,00 to 99,99.

The 0 value disables the function (the weighing cycle ends and the belts are instantaneously stopped).

(!) 00.00

<< BLK.MOT >> IMPULSE DURATION OF EMERGENCY / MOTOR LOCK INPUT (IN.E.4) (in seconds)

Minimum duration of the impulse coming from the EMERGENCY / MOTOR LOCK input (IN.E.4) in order for it to be considered valid by the instrument in order for it to enable the "EMERGENCY / MOTOR LOCK" alarm condition, end the weighing cycle, and stop the belts. The cycle will restart as soon as the input is disabled. The settable values go from 0,00 to 99,99.

The 0 value disables the function (the impulse is instantaneously considered).

(!) 00.00

The following step allows to enter all the weighing belt parameters in order to automatically calculate the weight positioning time and, only for the dynamic weighing, the average weight time, and the setting of the speed variation coefficient through the IN7 input.

<< en.a.pos >> ENABLING THE AUTOMATIC PACK POSITIONING**<< speed >> SETTING OF THE BELT SPEED**

Enter the belt speed, in m/min.

By using the variation of time periods function through IN7 input, one needs to set this step and calculate the time for the maximum speed.

The enterable values are from 0m/min to 100m/min

(!) 000

<< s.coeff >> SETTING THE COEFFICIENT OF SPEED VARIATION

Enter the coefficient of speed variation, related to the minimum speed in reference to the maximum one.

By enabling the IN7 input during the weighing cycle, the << R.ESP. >>, << EVAC. >> and << TRF.LGT >> times will be multiplied for the set coefficient.

(!) 1.00

<< belt l. >> SETTING THE BELT LENGTH

Enter the length of the weighing space, in other words, the space in which the weigh takes place. Enter the value in m, with two decimal digits.

The enterable values go from 0.00m to 9.99m.

(!) 0.00

<< pack. l. >> SETTING THE PACK LENGTH

Enter the length of the longest pack which will be weighed, in m, with two decimal digits.

The enterable values go from 0.00m to 9.99m.

(!) 0.00

<< d.phc >> SETTING THE DISTANCE between THE PHOTO CELLS

Enter the distance of the photo cell from the start of the weighing belt.

The enterable values go from 0.00m to 9.99m.

(!) 0.00

NOTE: The automatic calculation of the pack positioning and weighing time takes place each time that one exits the << en.a.pos >> step and at least one of its parameters has been modified (excluding the << s.coeff >> step); therefore, if one exits the step after having confirmed the already entered values, the calculation is not carried out.

In any case it is possible to manually correct the weighing and positioning time.

Diagram of the instrument weigh time (with weigh start on the leading edge of the FTC):

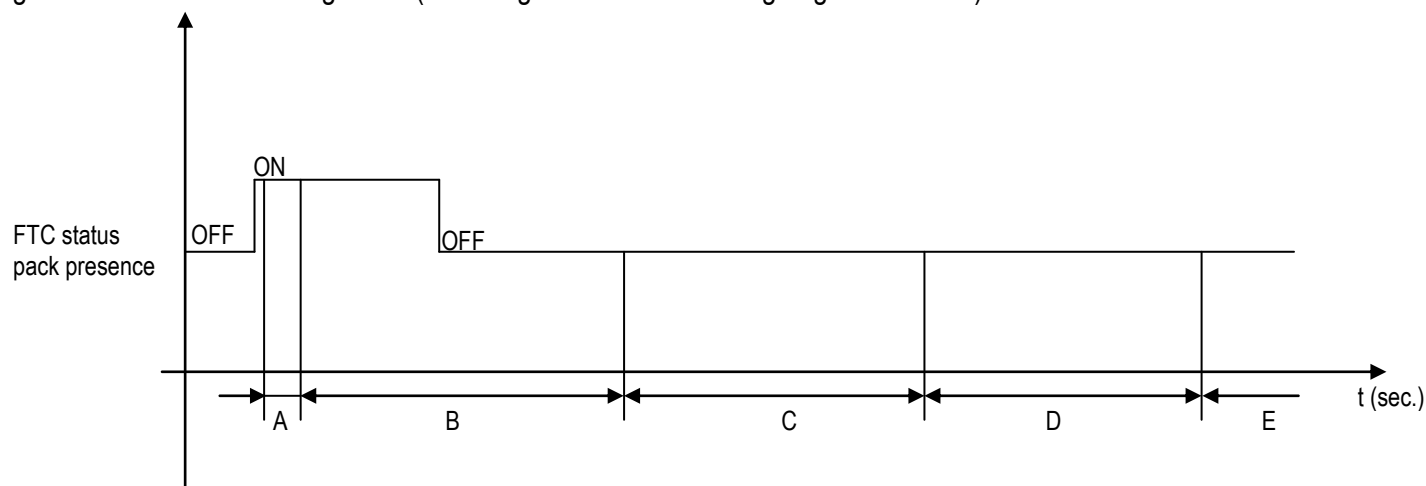

A: photo cell obscuring time

B: pack positioning time

C: weigh time

D: control light / expulsion activation time

E: scale ready to execute a new weigh

<< dis.d.st >> EXCLUDING CONSENSUS FROM DOWNSTREAM

Through this step it's possible to exclude the management of the consensus input from downstream (IN.1), always enabling the weighing cycle. Excluding the consensus from downstream is useful in cases in which the input is not necessary, for example if there is no belt and one does not want to use an input for enabling the weighing cycle.

Enable exclusion enabled.

Disable exclusion disabled.

Refer to the user manual (**USER MAN.REF.**) for further details.

(!) Disable

<< N.W.Tol >> NUMBER OF WEIGHS WITHIN TOLERANCE FOR AUTOMATIC TARGET RECALCULATION

Set the number of weighs within tolerance after which the target is automatically recalculated (for the functioning details see section "AUTOMATIC TARGET RECALCULATION AFTER N WEIGHS WITHIN TOLERANCE", **USER MAN.REF.**)

The settable values are from 0 to 65535; by inserting the 0 value the function is disabled.

(!) 00000

<< totAL >> TOTALIZER

<< Reset >> CONFIRM RESET

It is possible to select the automatic resetting of the totals when these are printed (**Disable**) or the resetting upon request (**Enable**).

(!) Enable

<< react >> REENABLING OF THE PRINTOUTS

It is possible to set the re-enabling of the simple print function in the following modes: "passage of the net weight by zero" or "weight instability".

PASS.0 passage of the net weight by zero

InStAb instability

NOTE: The totalisation function is always active.

(!) PASS.0

<< LOGO >> TEXT UPON START-UP

At the start-up of the indicator, the LCD display shows a message of 2 lines of 16 characters, which is set in this step, or a 160x32 pixel photo uploadable from Dinitools™ ("*.bmp" monochromatic format is accepted).

<< tXt >> INPUT TEXTS

<< CFG.tXt >> INPUT TEXT CONFIGURATION

Through this step one can enter, modify or cancel the heading of the input texts which will be filled in during the weighing through the F4 key of the indicator; refer to the user manual for further specifications. (USER MAN.REF.).

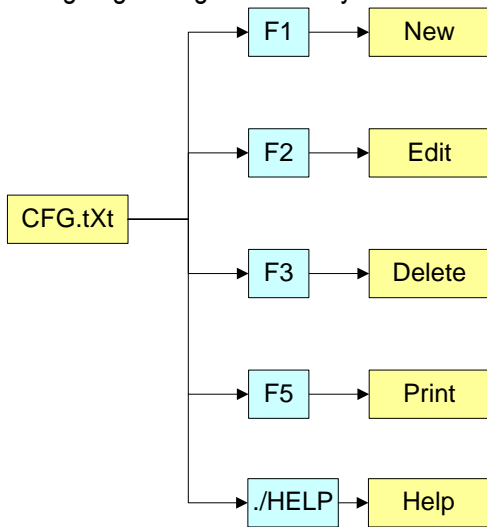
**ENTRY**

- Press **ENTER** to enter in the step.
- Select the eventual desired position through the arrow ▲ ▼ keys (or with the keyboard digit the position number).
- Press **F1** to enter the text in the desired position, or the first free position, if an already occupied position has been selected.
- The display shows “DESCRIPTION” and one can now enter the heading of the input text (up to 16 characters); press **ENTER** to confirm.
- The display shows “TEXT” and one can enter the contents of the input text (up to 32 characters); press **ENTER** to confirm.
- The display shows “THRESHOLD” and one can enter the maximum number of alphanumeric characters enterable in the field “TEXT”; press **ENTER** to confirm.
- The display shows “MANDATORY INPUT”, if one chooses “Enable” it is possible to exit from the input phase only if the text isn’t null; press **ENTER** to confirm.
- The display shows “ONLY VOID INPUT”; if one chooses “Enable” it is possible to modify the text only if it is null; press **ENTER** to confirm.
- **NOTE:** The threshold entered here defines also the field length for the compilation through the **F4** key in the weighing phase; if no text is inserted, the length is set at 32 characters.

MODIFICATION

- Press **ENTER** to enter in the step.
- Select the storage to be modified through the arrow ▲ ▼ keys (or with the keyboard digit the position number) and press **F2**.
- Modify the desired fields, listed in the previous section.
- **NOTE:** The text entered here defines also the field length for the compilation through the **F4** key in the weighing phase; if no text is inserted, the length is set at 32 characters.

CANCELLATION

- Press **ENTER** to enter in the step.
- Select the storage to be cancelled through the arrow ▲ ▼ keys (or with the keyboard digit the position number) and press **F3**.
- The indicator requests a further confirmation: press **ENTER** to confirm or another key to cancel.

PRINTING

- Press **ENTER** to enter in the step.
- Once inside it, press the **F5** key to print all the input texts. The LCD display shows the message “PRINT ?”: confirm with the **ENTER** key to print the whole input texts’ database.

HELP

By pressing the **.HELP** key, it's possible to see the keys list used in the menu.

The key list is automatically. If you want to see the keys list, in manual mode, use the arrow key (**F6** or **F7** key).

<< **D.THRES** >> DATA LENGTH THRESHOLD FROM READER

If one enables the compilation function of the free texts through the bar code reader / badge (see relative manual), In this step one can define a length (from 00 to 31) which conditions the storage of data ready. If the datum has a length less or equal to the predefined one; it is stored in the first input text; otherwise it is stored in the second one.

NOTE: the function has been enabled on the serial port selected in the **Setup >> Serial >> READER** step, or on the PC KEYBOARD input, by selecting the "Reader" parameter in the **Setup >> PC.KEYB >> KEYUSE** step.

(!) 00

<< **txt.i** >> ENTRY OF HEADINGS

Up to 3 lines x 24 characters of text can be entered that will be printed if programmed in the printout formats. The text entered will remain stored and printed until it is either cancelled or substituted.

<< **cLr.rAM** >> BUFFERED RAM RESET

The indicator has a buffered RAM memory (not volatile when power is removed) inside which is the database data, the input texts, the print formats and the heading.

The cancellation is not immediate; the indicator requests a further confirmation (the display shows "SurE?"): press **ENTER** to confirm (the indicator exits the SET-UP executing the start-up cycle); press another key to cancel.

Note: - CALIBRATION DATA ARE NOT CANCELLED.

-- THE FUNCTION DOES NOT ENABLE THE STANDARD PARAMETERS OF THE INSTRUMENT

<< **dtb.PWD** >> SET DATABASE ACCESS PASSWORD

By confirming the **Enable** setting one may insert a password of up to 5 digits, which will inhibit the entry, modification or cancellation of the databases, during the weighing.

The settable values run from 0 to 65534; by setting **Disable**, this password is disabled.

See section "DATABASE ACCESS PASSWORD" (**USER MAN.REF.**).

(!) **Disable**

<< **taMAG** >> TAMAGOTCHI

One enters the "NUMBER of MONTHS" passed (2 digits, **MONTHS** parameters), and the "NUMBER of the WEIGHS" made (5 digits, **WEIGH.** parameter) **since the last calibration**; after this, one is advised to recalibrate the instrument.

By pressing **ENTER** one passes to a submenu:

- **MONTHS** >>> Setting of Months
- **WEIGH.** >>> Setting of Weighs
- **Reset** >>> Clearing of Months and Weighs from the last calibration

If you set the number of months and the weighing to zero, this function will be disabled.

In any case it is possible to activate a choice of the number of months (MAX 99) or the number of weighs (MAX 99999) by setting at 0 the undesired parameter.

At start-up and every day at 11:00 o'clock, the indicator will be checking for the number of weighing and the number of months that have passed since the last calibration. If one of the values or both are equal or higher than the previously set values, the message "WE ADVISE TO RECALIB. SCALE" appears in the display and an intermitting sound is emitted. By pressing any key, the indicator will make a countdown and then it enters in the normal scale functioning mode.

NOTE: The number of weighs is decreased when, after passing by zero, there is a stable weight and greater than 4 divisions on the scale.

(!) **MONTHS 00; WEIGH. 00000.**

<< Setup >> **SCALE CONFIGURATION**<< Config >> **METRIC CONFIGURATION**<< Param. >> METRIC PARAMETERS<< (*) **Stabil.** >> FILTERING INTEGRATION

By pressing the **ENTER** key one accesses the selection of the type and degree of filter intervention for the stability of the weight indication:

FLT 3 - FLT 0

200.slo, 200.nor, 200.med, 200.fas

100.slo, 100.nor, 100.med, 100.fas

50.slo, 50.nor, 50.med, 50.fas

H.R.3 – H.R.0

Custom

Simple weighing filter

200Hz dynamic weighing filter

100Hz dynamic weighing filter

50H dynamic weighing filter

Filter for high resolution systems

Customized filter for use of the manufacturer

The higher the filter value, and greater is its intervention relative to the type of filter used.

(!) Custom

<< (*) **Auto 0** >> AUTOZERO AT START-UP

Automatic acquisition of the gross zero at start-up.

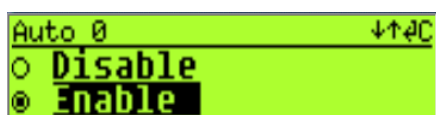

- Disabled

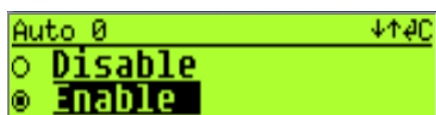

- Enabled



Percentage of zeroing

Set percentage of zeroing commensurate with the range (compresa tra +/-1 e +/- 50 %).

See section "POWER SUPPLY & START-UP" (**USER MAN.REF.**) for details on the functioning.

(*) with approved instrument,

by confirming the setting of EnABLE it is possible to modify the clearing percentage between +/-1 and +/-10 %.

(!) Enable, +/-10 %

<< (*) **0.PErC** >> ZERO FUNCTIONS IN WEIGHING PHASE

Acquisition of the gross zero through the ZERO key or through the WEIGHING BELT AUTOZERO function.



Clearing percentage
(blinking)

Set the clearing percentage in relation to the capacity (in between +/-1 and +/- 50 %).

By entering the 0 value, it's possible to disable the ZERO functions in the weighing phase.

See section "SCALE ZERO FUNCTION" (**USER MAN.REF.**) for functioning details.

(*) In case of approved instrument, the settable values are between 0 and 2.

(!) +/-2 %

<< **WARMUP** >> WARM-UP PHASE

It is possible to set a time in which, during the start-up phase, a brief preheating is made of the instrument electronics, in order to optimize the weighing.

The settable values go from 00 to 60 sec.

The 00 value disables the function.

(!) 00

<< (*) **0.Track.** >> ZERO TRACKING

This menu allows setting the zero tracking, in other words, the compensation parameter of the scale's thermal drift. The set value corresponds to the number of **stable divisions per 1 second** that one desires to compensate.

TR. ½ +/- half division.

TR.¼ +/- one fourth of a division

TR. 1 +/- one division.

TR. 2 +/- two divisions.

TR. no tracking disabled.

(*) In case of approved instrument, by entering the step one views the set value; by pressing **ENTER** it's possible to modify the parameter and choose one of the following values: **TR. no**, **TR. ½**, **TR. ¼**.

(!) **TR. ½**

<< (*) **Div.Stb.** >> DIVISIONS BY STABILITY

In this step one enters the number of divisions by which the instrument detects the weight stability; the higher the number of divisions, less is the sensitivity, and consequently the stability is more easily detected. The possible values are 0...99; by setting the 0 value, the check is disabled.

(*) If the indicator is approved, the step is read only.

(!) 2

<< (*) **GRAV** >> GRAVITY ZONE AND ZONE OF USE

In this step one selects the gravitational acceleration value **of calibration and of use** of the instrument:

Manual entry of the g value: the instrument is ready for the manual entry of the gravitational acceleration value.

If one enters a wrong g value: the minimum decimal value is proposed (9,75001); by a wrong g value one intends a decimal number not including between 9,75001 and 9,84999 (included).

(!) **g = 9,80655**

(*) In case of approved instrument the parameter is read only.

<< (*) **CALib.** >> SCALE CALIBRATION

See section "CALIBRATION".

(*) In case of approved instrument some parameters inside this step are read only.

<< (*) **0.CALib.** >> ZERO CALIBRATION

See section "CALIBRATION".

(*) In case of approved instrument the parameter is not visible.

<< **Serial** >> **SERIALS, PRINTOUTS, ETC...**

<< **PORTS** >> SERIAL CONFIGURATION

By pressing **ENTER** it's possible to choose the most adequate combination for the use of the three serial ports on the indicator hardware (**COM1**, **COM2**, **COM3**):

<< ERR.CTS >> CTS STATUS ERROR

By enabling this error, it is possible to block in advance the print or totalisation function, if recalled with an already active synchronism signal (see previous step): the indicator display will show the message "PRINTER ERROR: CHECK THE CTS!" for a few seconds and return to the weighing phase without carrying out the function. Press F6/F7 to Enable (enabled) or Disable (disabled), and ENTER to confirm.

(!) Disable

<< pwrprn >> PRINTER POWER SUPPLY

On the indicator board there is a terminal board called V-AUX (auxiliary power supply), thanks to which it is possible to power the devices (for example a printer); refer to the electric scheme for the characteristics.

In this step one programmes the functioning of the auxiliary output and the management of a possible connected printer:

pwrxt with instrument on, printer managed and auxiliary output always active.

pwrnt printer managed, auxiliary output active only when the instrument executes a printout.

extoff printer managed and auxiliary output always active; the start-up characters are sent to the printer, because the printer is considered to be configured in the energy saving mode.

(!) pwrxt

<< Protoc. >> SELECTS PROTOCOL

Normal Print

ripe 6 Dini Argeo 6-digit repeater.

ALIBI print/alibi memory

Cont. continuous transmission

For the protocol specifications, see section "TRANSMISSION PROTOCOLS".

(!) Normal

<< Com pc >> PC SERIAL CONFIGURATION**<< Baud >> SET BAUD RATE**

By pressing the **ENTER** key one accesses the selection of the data transmission speed (measured in Baud = bit/second). The possible values are: 1200, 2400, 4800, 9600, 19200, 38400, 57600, 115200.

(!) 9600

<< Parity >> SET PARITY

By pressing the **ENTER** key one accesses the selection of the parity bit type. The possible values are: nonE (absent parity bits), odd (uneven parity bits) e EVEEn (even parity bits).

(!) None

<< Word >> SET WORD

By pressing the **ENTER** key one accesses the selection of the number of data bits. The possible values are: 8 (8 data bits) and 7 (7 data bits).

(!) 8

<< Stop B. >> SET STOP BIT

By pressing the **ENTER** key one can then select the number of stop bits. The possible values are: 1 (1-stop bit) and 2 (2 stop bits)

(!) 1

<< CTS.ST. >> SYNCHRONISM SIGNAL

On the serial line set as COM.PRN the indicator can manage a synchronism signal

- by using the dedicated CTS (Clear To Send) input, if one uses the COM2 port, or

- by using the RX input, if one uses the COM1 or COM3 port (in this case, by enabling the function, this input will no longer be managed for other reception functions).

A device (like a printer) that is slow in processing the data received, can interrupt the transmission temporarily using this signal.

It is possible to select:

NO.CTS Disabled (ITALORA WITTY280 e SMT280)

LOW CTS active low (LP522/542, EPSON LX300, TM295, TPR, LP542PLUS, TTP243, LP542S, SMTPLUS)

HIGH CTS active high (DP190)

EMUCTS Emulation of CTS signal: one is asked to enter the number of characters (nChrS) using 3 digits, which will be transmitted upon each transmission; then one should enter the wait time in milliseconds (tiME), using 4 digits, from a transmission and the next one.

(!) NO.CTS

<< Add.485 >> 485 ADDRESS

By pressing the **ENTER** key one accesses the insertion of a code of 2 digits (from 00 to 98) which identify the instrument among those connected in the RS485 transmission mode, on the PC serial port.

NOTE: the 99 code is used as a broadcast address.

(!) 00

<< Protoc. >> SELECTS PROTOCOL

StAnd Standard

AFX AFOX

ripe 6 Dini Argeo 6-digit repeater

mondir Uni-directional

ALIBI Alibi memory

SMA SMA protocol

MODBUS Modbus protocol

PROFI.B Profibus protocol

For the protocol specifications, see section "TRANSMISSION PROTOCOLS".

(!) StAnd

<< PC.Mode >> TRANSMISSION TYPE

Reque. On request

Cont. Continuous

Stabil. On stability

- 485 - 485 mode

For the transmission mode specifics, see the section "TRANSMISSION MODES".

(!) Reque.

<< ComAux >> CONFIGURATION AUX SERIAL

<< Baud >> SET BAUD RATE

By pressing **ENTER** one can select the data transmission speed (measured in Baud = bit/second). The possible values are: 2400, 4800, 9600, 19200, 38400, 57600, 115200.

(!) 9600

<< Parity >> SET PARITY

By pressing **ENTER** one can select the parity bit type. The possible values are: nonE (absent parity bit), odd (uneven parity bit) and EVE (even parity bit).

(!) None

<< Stop B. >> SET STOP BIT

By pressing **ENTER** one accesses the selection of the stop bit number. The possible values are: 1 (1 stop bit) and 2 (2 stop bits).

(!) 1

<<Word>> SET WORD

By pressing **ENTER** one can select the number of data bits. The possible values are: 8 (8 data bits) and 7 (7 data bits).

(!) 8

<< CTS.ST. >> SYNCHRONISM SIGNAL

Not used in this application.

<<Protoc.>> SELECTS PROTOCOL

None no protocol

Cont. continuous transmission

ripe 6 Dini Argeo 6-digit repeater.

For the protocol specifications, see "TRANSMISSION PROTOCOLS" section.

(!) **nonE**

<< READER >> READER PROTOCOL

Enabling data reception from external reader (See relative manual)

DISABLE disabled

COM.AUX enabled on the ComAux

COM.PRN enabled on the ComPrn

(!) **DISABLE**

<< R71.REP. >> R71 REPEATER

If the R71620 is connected to the indicator, through this step, it is possible to enable the dedicated protocol on the serial ports on which the "riPE 6" protocol is enabled.

Disable Disabled

Enable Enabled

(!) **Disable**

<< Prn.FMt >> PRINT CONFIGURATION

Through this step one can configure up to 30 print formats directly from the indicator.

In this step it is possible to choose the number of format to be configured; therefore enter, modify or eliminate the print blocks following the instructions shown in section **10 PROGRAMMING THE PRINTOUTS**.

<< Termin >> SET TERMINATOR TYPE

When connecting a printer it is often necessary to transmit one of the following protocols in order to define the end of the print line.

CR CR (for DP190, LP522/542, TPR)

CR LF CR LF (for EPSON LX300 and TMU295).

LF LF

NO.TERM NO TERMINATOR (for LP542 Plus, TTP243 and ITALORA COMPATIBLE)

(!) **CR**

<< DEF.PRN >> PRINTOUT DEFAULT

By pressing **ENTER** one is asked to confirm the activation of the standard printouts: the display shows "SurE?": press **ENTER** again to confirm or another key to cancel the operation.

The printout default is configured only for TPR printer.

WARNING: in this way the formatted printouts will be CANCELLED and SUBSTITUTED by the standard formats.

<< Anout >> ANALOGUE OUTPUT (OPTIONAL)

See the section "ANALOGUE OUTPUT (OPTIONAL)" for configuring it.

<<SLOT >> SLOT SELECTION

One selects the SLOT to be used with the analogue output: SLOT 1 or SLOT2.

(!) **SLOT 1**

<< MODE >> OPERATING MODE

AO G = analogue output on the gross weight

AO N = analogue output on the net weight

AO.BELT = analogue output with value from article to manage the belt speed.

(!) **AO G**

<< AOMA >> MAXIMUM VALUE

Setting of the maximum value of the analogue output.

<< AOZE >> ZERO SCALE VALUE

Setting of the analogue output value when the scale displays zero weight.

<< AOMI >> MINIMUM VALUE

Setting of the minimum value of the analogue output.

<< inF.rEd >> REMOTE CONTROL CONFIGURATION

None Remote control disabled.

RD 6 Radio remote control with 6 keys to associate to the instrument.

The remote control only works if it is associated to the instrument using the procedure described in the user manual. The maximum number of remote controls that can be associated is 3.

RD.BR 6 Radio remote control with 6 keys. The instrument works with any radio remote controls supplied by us.

The remote control keys are configurable in the follow way:

KEY 1 key 1

None NO INPUT

tArE TARE KEY

C C KEY

2nd F 2nd F KEY

ENTER/Fn ENTER/Fn KEY

Point DECIMAL POINT

F1 F1 KEY

F2 F2 KEY

F3 F3 KEY

F4 F4 KEY

F5 F5 KEY

F6 F6 KEY

F7 F7 KEY

F8 F8 KEY

F9 F9 KEY

F10 F10 KEY

- 0 - NUMERIC ZERO KEY

- 1 - ONE KEY

- 2 - TWO KEY

- 3 - THREE KEY

- 4 - FOUR KEY

- 5 - FIVE KEY

- 6 - SIX KEY

- 7 - SEVEN KEY

- 8 - EIGHT KEY

- 9 - NINE KEY

PLt - 0 ENABLE REMOTE SCALE

PLt - 1 ENABLE SCALE 1

PLt - 2 ENABLE SCALE 2

PLt - 3 ENABLE SCALE 3

PLt - 4 ENABLE SCALE 4

LoC.in KEYBOARD LOCK

oFF TURNING OFF THE INDICATOR

- oK - OK MESSAGE

Error ERROR MESSAGE

rEAdY READY MESSAGE
StArt START MESSAGE
StoP STOP MESSAGE
rL.oFF SETS ALL THE OUTPUTS AT OFF
LnG.KEY SETS KEY PRESSED AT LENGTH
LEVEL SETS LEVEL CHECK
MNU.FUN EXECUTION OF A SPECIFIC FUNCTION

Select from a menu the function to execute when pressing the relative key on the remote control. The menu lists all the functions contained in the table described at paragraph 3.2 (<<F.kEyS>>).

(!) None

The same configurations are valid for:

kEy 2 key 2
kEy 3 key 3
kEy 4 key 4
kEy 5 key 5
kEy 6 key 6

NOTE: The function of the prolonged pressure of the keys is repeatable also on the remote control.

<< Tare T. >> TARE LOCK/UNLOCK

Lock LOCKED TARE
Unlock UNLOCKED TARE
Disable DISABLED TARE

See the section "LOCKED / UNLOCKED TARE" (**USER MAN.REF.**) for the functioning specifics.

NOTE: during the weighing it is possible to lock / unlock the tare by pressing at length the F5 key.

(!) LoCK

<< ZOOM.W >> WEIGHT ZOOM

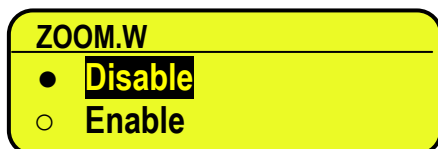

- Disable

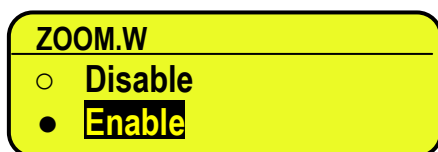

- Enable

ENTER →

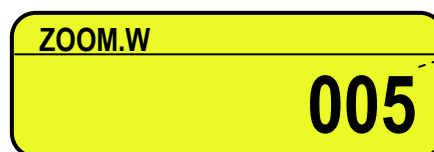

Activation delay
(blinking)

Insert the activation delay (included between 0 and 255 sec.).

See section "WEIGHT ZOOM" (**USER MAN.REF.**) for the functioning details.

(!) Enable, 005 sec.

<< Pow.Off >> AUTO SWITCH OFF

One enables/disables the auto switch-off after the scale is not used for 5 minutes, with plate unloaded.

Enable auto switch-off ENABLED
Disable auto switch-off DISABLED

(!) Enable

<< **Bt.Stat.** >> **BATTERY LEVEL INDICATION**

One selects whether to enable or disable the software check of the battery charge level: each time that the charge goes down of level, it is notified through the symbols on the display. See section "BATTERY LEVEL INDICATION", **USER MAN.REF.**.

Enable check ENABLED

Disable check DISABLED

(!) Disable

NOTE: by enabling the indication of the battery level, the backlight automatically switches off when there is no keyboard activity for at least 15 seconds.

<< **baCkuP** >> **INSTRUMENT DATA BACKUP**

Selecting ENTER the indicator display displays SurE ? : press ENTER to confirm or C to cancel the operation. The backup saves the entire configuration in the internal memory of the instrument, except for archives.

<< **Dflt** >> **STANDARD DEFAULT**

This parameter resets the parameters to the factory settings of all the parameters and resets the print sizes.n

Pressing ENTER the indicator will show two different views on the LCD if there is a valid backup or less:

WITHOUT BACKUP:	Dflt ←C SURE ?	WITH BACKUP:	Dflt F1 ←C ENTER=FACTORY DEFAULT F1=LOAD FROM BACKUP
--------------------	---	--------------	---

Press **ENTER** to confirm to C to cancel the operation.

Press **F1** to load the saved configuration or **ENTER** to restore normally

NOTA: LA CALIBRAZIONE, GLI ARCHIVI, I TESTI DI INPUT e L'INTESTAZIONE NON VENGONO CANCELLATI.

<< (*) **Dflt.t** >> **TECHNICAL DEFAULT**

By pressing **ENTER** the indicator activates the default parameters (shown in bold and preceded by an exclamation point at the end of each step), the standard printouts, initialises the database (TARE and ARTICLE), cancels the input texts, the heading and **THE CALIBRATION**; the display shows **SurE?**: press the **ENTER** key to confirm (the indicator exits the SET-UP executing the start-up cycle) or **C** to cancel the operation.

(*) In case of approved instrument the step is not accessible.

<< **Pwd.Set** **SET ACCESS PASSWORD TO SET-UP ENVIRONMENT**

One configures whether to enable or disable the access password to the technical menu:

Enable password ENABLED

Disable password DISABLED

By selecting EnAbLE, the instrument predisposes itself for the password entry, made up of up to 5 digits; when finished entering confirm with **ENTER**.

The enterable value are from 0 to 65534.

See section "SETUP ENVIRONMENT" for the functioning specifics.

(!) Disable(*) << **ini.AL** >> **INITIALIZES ALIBI MEMORY****(Visible only with non approved instrument)**

The initialisation cancels all the data stored in the Alibi memory; by pressing **ENTER** one is asked to confirm the operation. The display shows **SurE?**; press **ENTER** again to confirm or another key to cancel.

At the end the " AL.OK " message appears if the operation is made with success; otherwise the " AL.ERR" message is displayed.

(*) In case of approved instrument the step is not accessible.

(*) << D.SALE >> DIRECT SALE

- **NO** limitations disabled
- **YES** limitations enabled

By enabling the step, one will be asked to configure the <<REM.DSP>> parameter. If one sets **yES** also for this parameter, the activation of the x10 visualization is possible.

Refer to the user manual for the functioning description (**USER MAN.REF.**).

(!) NO

(*) In case of approved instrument the step is not accessible.

<< PC.KEYB >> PC KEYBOARD CONFIGURATION**<< KEYUSE >> USE OF PC KEYBOARD INPUT**

Normal Use of the external PC keyboard (see in the user manual section "INDICATOR CONNECTED TO PC KEYBOARD").

READER Enabling data reception from external reader (See relative manual)

(!) Normal

<< LAYOUT >> EXTERNAL PC KEYBOARD LANGUAGE

US.EN american /english

DEUT german

FRAN french

ITAL Italian

(!) US.EN

<< Diag. >> DIAGNOSTICS MENU

It's a submenu inside of which it is possible to check the software and hardware components of the scale, accessible also during the weighing, keeping the **F4** key pressed at length.

<< Prg.Ver. >> FIRMWARE

Software version checking.

<< Weight >> WEIGHT

By pressing **ENTER** the display shows:

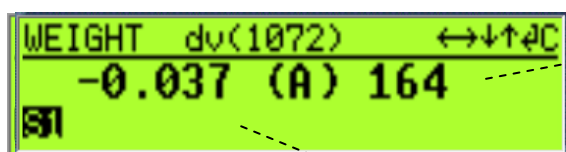

Controlled scale

Converter points per division

weight and type of cells (A)=Analog (D)=Digital

<< Milliv >> MILL VOLT

Checking the cell signal in mill volts, in three decimals.

<< ADC.Pnt >> CONVERTER POINTS

Check of the A/D converter points.

By pressing **ENTER** the display shows:

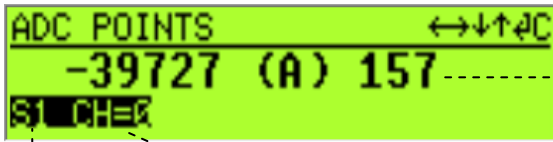

weight and type of cells (A)=Analog (D)=Digital

Controller scale

Controller channel

In the case the load cell is not connected or faulty, or the A/D converter is faulty, it is possible that floating values are shown, or the message "Err.C.XX" appears (in which XX is the number of channel / digital load cell on which the faulty is detected), if the signal exceed the underload / overload value of the converter.

To check if the A/D converter is faulty, disconnect the channel on which the faulty is detected and make a short between SIG+ and SIG-; with non faulty A/D converter a mV value proximate to 0.000 will be displayed.

<< Display >> **DISPLAY TEST**

By pressing **ENTER** the instrument shows the display version and the led turns on.

<< Keyb. >> **KEYBOARD TEST**

By pressing **ENTER** the instrument displays 0000; by pressing the keys one at a time, the relative codes are shown on the display. One exits pressing the same key three times.

<< Cts.St. >> **TEST OF THE CTS STATUS**

By pressing **ENTER** one views the status/level of the CTS signal of the printer (on) connected to the PRT serial port. If the second CTS is enabled it's possible to scroll with the arrow keys \blacktriangle \blacktriangledown to display also the status of this signal.

<< B.Level >> **BATTERY LEVEL**

By pressing **ENTER** the display shows the input value of the battery on the motherboard, read by the analogue-digital converter.

<< Power >> **POWER SUPPLY VOLTAGE**

By pressing **ENTER** the display shows the input value of the power adapter on the motherboard, ready by the analogue-digital converter.

<< RELE >> **OUTPUT TEST**

By pressing **ENTER** it is possible to test all the available outputs, by selecting these one by one with the \blacktriangle \blacktriangledown arrow keys; these will be enabled:

RL.01	OUT1	
...		Relay of the main board.
RL.04	OUT4	
RL.05	OUT5	
...		Relay of the expansion board (optional).
RL.16	OUT16	

<< inPutS >> **INPUT TEST**

By pressing **ENTER** it's possible to test the status of the inputs; the display will show:

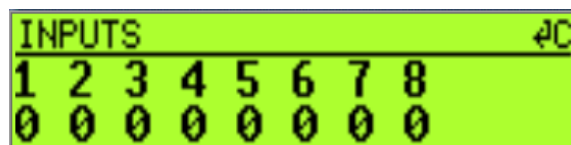

in which the number on the first line identifies the input:

1	IN1	
...		Inputs of the motherboard
3	IN3	
4	IN4	
...		Inputs of the expansion board
8	IN8	

and the number each input corresponds to its status:

0 = disabled;

1 = enabled.

<< Anout >> ANALOGUE OUTPUT TEST

If the instrument is fitted with the analogue output, through this step one can test if the values of the D/A converter (to be entered at time of calibration) correspond with the relative values of the analogue output (in voltage or in current), see paragraph "ANALOGUE OUTPUT (OPTIONAL)".

By pressing **ENTER** the display shows 00000; enter a value between 00000 and 65535 and confirm with **ENTER**; the instrument will supply the corresponding analogue value in output.

To exit the test confirm twice with **ENTER** the same entered value.

<< SER. >> SERIAL PORTS TEST

By pressing **ENTER** it's possible to redirect the data received by any serial port, on other serial ports.

<< SER.NUM >> SERIAL NUMBER

Diagnostics check for use of the manufacturer.

<< P.Test >>

Printing test for all the print formats of the instrument.

When one enters in this step, one is asked which format to be printed; if it inserts the zero value, the indicator prints all the formats sequentially.

<< Ev.Log >>

Step to view and print all the events of the instrument.

The indicator stores the following types of event:

- metric events (calibration, equalization)
- battery events (turn-on, turn-off, change supply, ...)
- keyboard events (pressing of a key)
- event to change the SETUP (default, backup, saving setup, ...)
- update firmware events (uploading firmware)
- network events

For each type the last 10 events with registration date/time are stored.

In this step it is possible to select which event shows and scrolls the last 10 events.

By pressing the F5 key, it is possible to print this list.

4. CALIBRATION

4.1 CALIBRATION PROCEDURE

1) Enter the Setup of the instrument:

(upon start-up, press for an instant the **TARE** key while the instrument version is displayed)

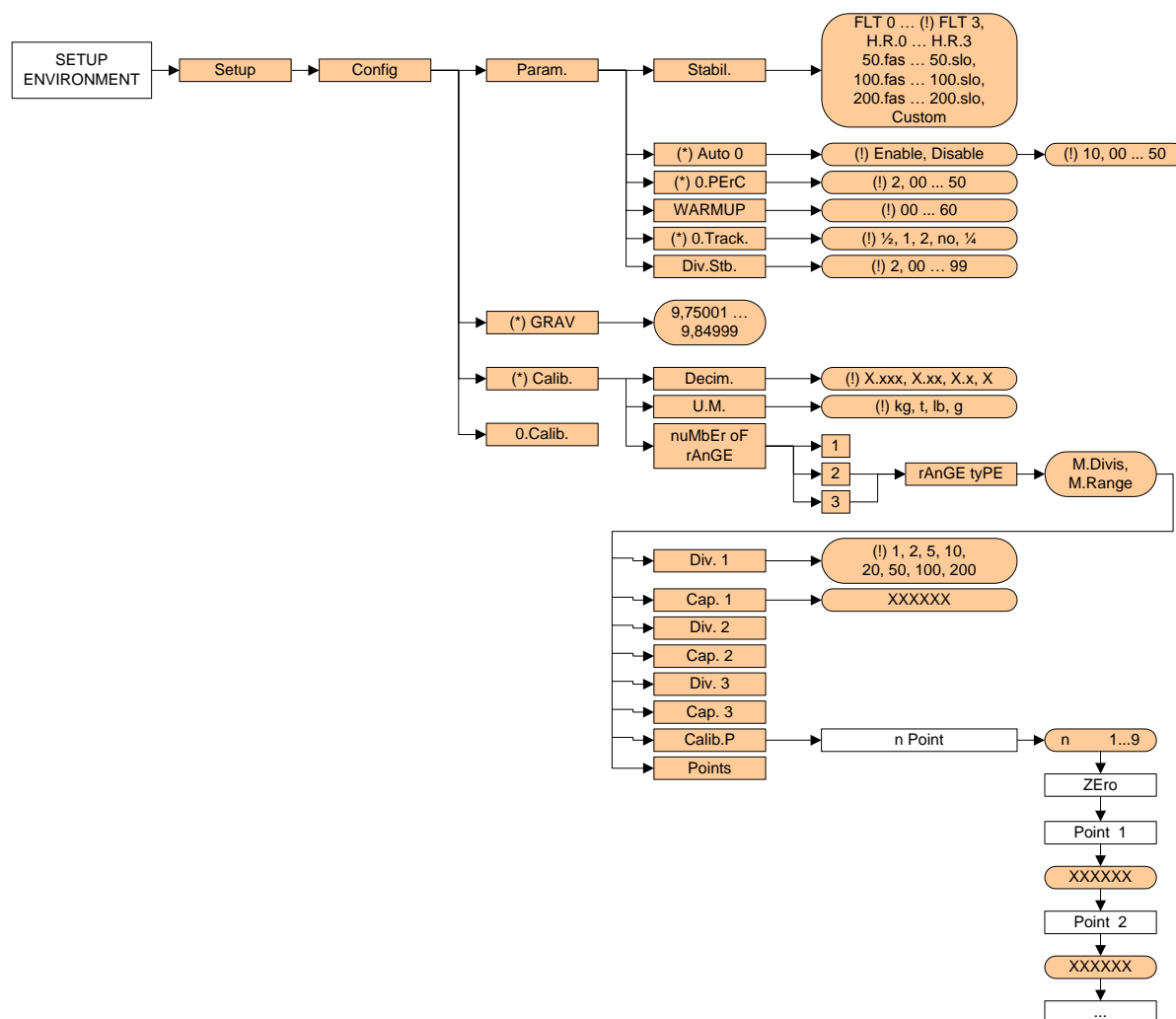

2) Enter in the configuration menu of the calibration in other words **Setup >> Config >> Calib.** and press **ENTER**.

3) Set the number of calibration decimals: select the **Decim.** step and press **ENTER**, with the **▼ ▲** keys move the decimal point in the desired position and press **ENTER**.
 (!) **0.000**

4) Set the unit of measure: select the **U.M.** step and press **ENTER**, with the **▼ ▲** keys select the unit of measure: grams (G), kilograms (kG), tons (t) or pounds (Lb) and press **ENTER**.
 (!) **kg**

5) Select the number of calibration range and confirm with **ENTER**

- if there is only one measuring range, select 1;
- with various fields (up to 3), the type of scale will be requested: select M.rAnGE (if a multirange scale) or M.diViS (if a multidivisional scale) and confirm with **ENTER**.

6) Set the division of the scale or the division of the first range: select the **Div. 1** step and press **ENTER**, with the **▼ ▲** keys select the value (1, 2, 5, 10, 20, 50, 100, 200) and press **ENTER**.
 (!) **0.001**

- 7) Set the capacity of the scale or the first range: select the **Cap.1** step and press **ENTER**, set the value (minimum 100 maximum 999999) and press **ENTER**.
TAKE NOTE: enter the whole value including the decimal digits; for example if the capacity should be over 6 kg and the division 0.001kg (= 1 g), set 6000, or if the capacity should be 1500 kg and the division 0.5 kg, set 15000.
(!) 0.100
NOTE: if the range number set in step 5) is equal to 1, pass directly to point 12)
- 8) Set the division of the second range: select step **Div. 2** and press **ENTER**, with the **▼ ▲** keys select the value (1, 2, 5, 10, 20, 50, 100, 200) and press **ENTER**.
(!) 0.001
- 9) Set the second range: select step **Cap.2** and press **ENTER**, set the value (minimum 100 maximum 999999) and press **ENTER**.
(!) 0.100
NOTE: if the range number set in step 5) is equal to 2, pass directly to point 12)
- 10) Set the division of the third range: select step **Div. 3** and press **ENTER**, with the **▼ ▲** keys select the value (1, 2, 5, 10, 20, 50, 100, 200) and press **ENTER**.
(!) 0.001
- 11) Set the third range: select step **Cap.3** and press **ENTER**, set the value (minimum 100 maximum 999999) and press **ENTER**.
(!) 0.100
- 12) Carry out the acquisition of the calibration points: select the **Calib.P** step and press **ENTER**.
 The instrument will request the following in this order:

Number of signal linearization points: appears the message "CALIBRATION POINTS" enter the value (from 1 to 8 points, besides ZERO) and press **ENTER**.

ZERO point: the "UNLOAD THE SCALE AND PRESS ENTER" message appears; unload the scale and press **ENTER**.

First linearization point: "WEIGHT CALIBRATION POINT 1" message will appear followed by the request to enter the value of the calibration weight; enter the value of the sample weight with the numeric keyboard → press **ENTER** → load the weight on the scale → press **ENTER**.

If the weight is sufficiently stable, the acquisition is executed, otherwise the display shows "ERROR: UNSTABLE WEIGHT". By pressing **ENTER**, the menu of the next possible operations is displayed: press **ENTER** to try again the acquisition of the point, **C** to exit from the step or **1** to accept anyway the acquired value. By pressing **C** immediately after the display of the error message, one exits from the steps.

Following calibration points: as the above.

- 13) Once the calibration is made, "CALIBRATION EXECUTED" message will appear on the display LCD.
- 14) Press the C key twice until the instrument asks for saving and confirming with **ENTER**.

4.2 LINEARISATION POINTS

By entering in the **Setup >> Config >> Calib. >> Points** step it's possible to access a menu which allows to view/modify the linearization points of the last calibration made:

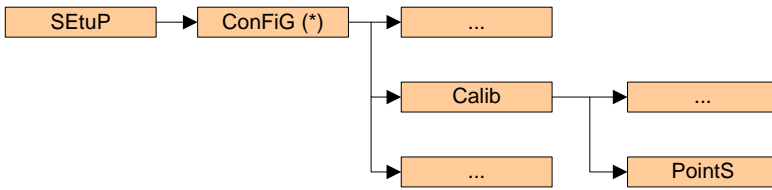

POINT	ADC. POINT	WEIGHT
0	█	0.000
ACT. 1	0	0.000

ENTER

ADC POINTS
+00000000

In the central row are indicated: the actual point, the value of the converter points or the mV signal and the value of the weight of corresponding calibration point.

NOTE: WEIGHT field or ADC.POINT field will be in reverse mode to indicate the selected field.

In the last row are indicated: the actual point of calibration (which refers the current weight), the value of points (or mV if switched) of current weight and the value of weight (if not calibrated shows hyphens).

KEYS' FUNCTIONS

F1	inserts a linearization point.
F2	deletes a linearization point.
F3	copies a linearization point (waiting stability).
F4	copies ADC.POINT data (waiting stability).
F5	quickly copies ADC.POINT data (without waiting stability).
F6 ▼	scrolls backward the points inside the menu.
F7 ▲	scrolls forward the points inside the menu.
F8 ◀ / F9 ▶	scroll between the converter points or the millivolt indication and the weight indication
ENTER	modifies a point (weight and converter points); while entering it confirm the values.
2nd F	switch from ADC.POINT to mV
C	exits the programming; one is asked to save (the display shows "ACTIVATE NEW CALIBRATION ?"): with ENTER one confirms, with another key one exits without saving. While entering a code, it quickly zeros the present value.
HELP	show keys function

4.3 ZONE OF USE DIFFERENT THAN THE ZONE OF CALIBRATION:

If the zone of use is different than the calibration zone, one should:

- 1) Enter in the Set-up of the instrument;
(upon start-up, press for an instant the **TARE** key while the instrument version is displayed)
- 2) Enter in the configuration menu of the metric parameters, in other words, **Setup >> Config** and press **ENTER**
- 3) Set the calibration zone: enter in the **GrAV** step and set the gravitational acceleration value of the CALIBRATION ZONE.
- 4) Execute the calibration, following the procedure shown in section "CALIBRATION PROCEDURE".
- 5) Set the zone of use: enter in the **GrAV** step and set the gravity acceleration value of the ZONE OF USE.
- 6) Press various times the C key until the instrument asks to save and confirm with ENTER.
- 7) The weight error caused by a different gravity attraction value between the zone of calibration and the zone of use is automatically corrected.

4.4 QUICK ZERO CALIBRATION

Useful for calibrating only the ZERO point when a permanent tare weight is put on a platform (for example a roller unit).

- 1) Enter in the instrument set-up;
(upon start-up, press for an instant the **TARE** key while the instrument version is displayed)
- 2) Enter in the configuration menu of the metric parameters, in other words, **Setup >> Config** and press ENTER
- 3) Select the **0.Calib.** step and press **ENTER;** the "UNLOAD THE SCALE AND PRESS ENTER" message appears.
- 4) Put the preset tare to be cleared on the scale or unload the scale and press ENTER
- 5) Once the calibration has taken place, "ZERO CALIBRATION EXECUTED" message will appear on the display LCD, press ENTER and the scale returns to the **Param.** step.
Press various times the C key until the instrument asks to save and confirm with ENTER.

5. DISPLAY OF THE GRAVITY ACCELERATION AND CORRECTION OF THE WEIGHING ERROR DUE TO THE DIFFERENT GRAVITATIONAL ACCELERATION BETWEEN CALIBRATION ZONE AND UTILISATION ZONE.

This instrument conforms to the laws currently in force regarding non-automatic weighing instruments. Such g-sensitive instruments are influenced by the gravitational acceleration value “g” of the utilisation zone hence it is compulsory to indicate, with a label or on the display, the coded name of the utilisation zone where the weighing machine can be used.

Therefore a special programme has been created to compensate for any differences in the gravitational attraction between the place where the weighing machine is calibrated and the place of utilisation. During configuration the “g” values relative to the utilisation zone and to the zone of calibration are entered at a certain programming step which eliminates the weight error introduced by the different gravitational attraction value. The instrument displays for a few seconds when turned on, by pressing the 2ndF key, after the name and the version of the installed software, the “g” value corresponding to the utilisation zone.

6. FUNCTION OF THE OPTOISOLATED INPUTS

INPUT	DESCRIPTION
IN1	<p>Lock from downstream / running of the system. With consensus from downstream not excluded in the << diS.d.st >> step:</p> <ul style="list-style-type: none"> - Until the input is active, the instrument can execute the weighing operations and the automation is active. - If the input is disabled (for a minimum time configured in step << BLK.D.ST >>), the instrument locks the automation until the input is once again enabled
IN2	<p>Pack presence/ Weigh start For still weigh or in motion:</p> <ul style="list-style-type: none"> - When the input is active, the instrument detects the presence of the pack and awaits the positioning time (set in the << POS.PAC >> step) before acquiring the weigh. - The minimum duration of the impulse is settable in the << IN.PhC >> step <p>For two-sensor weigh:</p> <ul style="list-style-type: none"> - One should connect the weigh start photo cell to this input.
IN3	<p>Cadence. When the input is active, the instrument detects the presence of the pack on the cadence belt, and verifies the conditions for its stopping (depending on what is set in step << 2.PAC >>); see the description of section "MANAGEMENT OF CADENCE PHOTOCELL AND BELT". The minimum duration of the impulse is settable in the << IN.PhC >> step.</p>
IN4	<p>Restart. It is possible to decide that the instrument, once the weigh has been executed, stops and waits for a Restart impulse to start again. The minimum duration of the impulse must be 0,05 sec. The input of the Restart, furthermore, must be enabled at the first start of the system (after the start-up) to enable the automation. If IN1 is open, restart don't work. If pressed at length, with the instrument out of the weighing cycle, it allows to print and to zero the lot total (see section "LOT WEIGHS REPORT" (USER MAN.REF.)).</p>
IN5	<p>Weigh end In the two-sensor weigh, one should connect the weigh end photo cell to this input.</p>
IN6	<p>Emergency / Motor lock</p> <ul style="list-style-type: none"> - Until the input is disabled, the instrument can execute the weighing operations and the automation is active. - If the input is enabled (for a minimum time configured in step << BLK.MOT >>), the instrument locks the automation and enters in the "EMERGENCY / MOTOR LOCK ALARM" up until the input is once again disabled.
IN7	<p>Time Periods variation If two functioning speeds are provided for with the belt, it is possible to modify the duration of the times used after the weigh execution, based on the speed that is being used, in order to enable correctly the eventual tolerance devices:</p> <ul style="list-style-type: none"> - Till the input is disabled, the instrument uses the time periods set in the << TIME >> step. - By enabling the input, the << R.ESP. >>, << EVAC. >> and << TRF.LGT >> times are multiplied to the coefficient set in the << s.coeff >> step. <p>NOTE: the functioning with 2 speeds requires the weighing with 2 sensors.</p>

7. FUNCTION OF THE OUTPUTS

RELAY	DESCRIPTION
OUT1 (motherboard) CADENCE BELT	Enabling / disabling of the cadence belt
OUT2 (motherboard) WEIGHING BELT	Enabling / disabling of the weighing belt
OUT3 (motherboard) GENERIC ALARM	It enables each time that the instrument detects an error condition and remains enabled for the duration of the alarm impulse (set in <<ALARM>> step): <ul style="list-style-type: none"> - Weight out of tolerance (only if the manual expulsion has been selected) - The number of weighs out of tolerance has reached the value set in the << n.W.STOP >> step - Weight unstable for a time greater than the value set in step << T.M.PES >> (only if the weighing at halt is selected) . - Pack not weighed at the restart of the belts (after the lock from downstream which took place before the end of the weigh). - Weight greater than the maximum Capacity + 9d or less than -100d, for a time greater than the value configured in step << W.UN.OV >> (only with time greater than 0). - EMERGENCY / MOTOR LOCK input (IN6) active for a time greater than the value configured in step << BLK.MOT >>.
OUT4 (motherboard) EJECTOR	If enabled (see <<TYP.ESP>> step), it activates each time that the instrument executes a weigh out of the tolerance range configured in the step << SET.RNG >>. Furthermore it is possible to set a output activation delay, calculated from the instant in which the weighing belt restarts after executing the weigh (see << Rit.Esp. >> step) NOTE: the ejector does not activate if the approval has been removed from the downstream (IN 1 = 0Vdc).
OUT5 (expansion) -T1 < WEIGHT < +T1	If the tolerance check is enabled (<< TST.TOL >> step), it activates as soon as the instrument totalizes the weigh and remains enabled for the activation time (settled in << TRF.LGT >> step), if this is within the range: $(TARGET - T1) \leq WEIGHT \leq (TARGET + T1)$
OUT6 (expansion) WEIGHT < -T3	If the tolerance check is enabled (<< TST.TOL >> step), it activates as soon as the instrument totalizes the weigh and remains enabled until the restart impulse, if this is < of $(TARGET - T3)$
OUT7 (expansion) WEIGHT < - T2	If the tolerance check is enabled (<< TST.TOL >> step), it activates as soon as the instrument totalizes the weigh and remains enabled until the restart impulse, if this is < than $(TARGET - T2)$.
OUT8 (expansion) WEIGHT < - T1	If the tolerance check is enabled (<< TST.TOL >> step), it activates as soon as the instrument totalizes the weigh and remains enabled until the restart impulse, if this is < than $(TARGET - T1)$.
OUT9 (expansion) WEIGHT > +T1	If the tolerance check is enabled (<< TST.TOL >> step), it activates as soon as the instrument totalizes the weigh and remains enabled until the restart impulse, if this is > than $(TARGET + T1)$.
OUT10 (expansion) WEIGHT > +T2	If the tolerance check is enabled (<< TST.TOL >> step), it activates as soon as the instrument totalizes the weigh and remains enabled until the restart impulse, if this is > than $(TARGET + T2)$.
OUT11 (expansion) WEIGHT > +T3	If the tolerance check is enabled (<< TST.TOL >> step), it activates as soon as the instrument totalizes the weigh and remains enabled until the restart impulse, if this is > of $(TARGET + T3)$

8. SERIAL OUTPUTS

The indicator is fitted with two bi-directional serial ports, both having the output in ASCII code compatible with a wide range of printers, remote displays, PCs and other devices; in the set-up it is possible to freely combine these ports to the available configurations (“ComPC”, “ComPrn”, and “ComAux”).

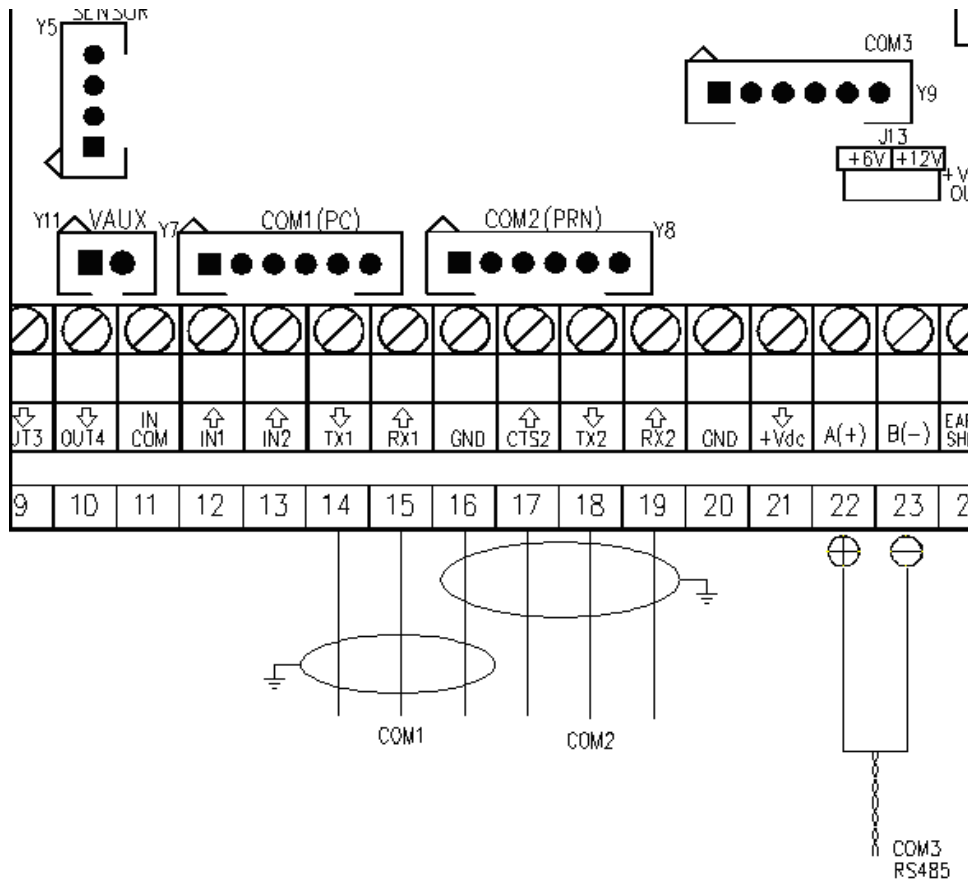

Signal	AMP Connector		Terminal board		
	COM1/COM3 (RS232)	COM2 (RS232)	COM1 (RS232)	COM2 (RS232)	COM3 (RS485)
TX	1	1	14	18	22 A(+)
RX	2	2	15	19	23 B(-)
GND	6	6	16	16	-
CTS	2	3	15	17	-

By the step **SEtuP >> SEriAL >> PortS** it is possible select the function of the serial ports:

Parameter	COM 1	COM 2	COM 3
PC.PR.AX (!)	ComPC	ComPrn	ComAux
PC.AX.PR	ComPC	ComAux	ComPrn
PR.PC.AX	ComPrn	ComPC	ComAux
PR.AX.PC	ComPrn	ComAux	ComPC
AX.PC.PR	ComAux	ComPC	ComPrn
AX.PR.PC	ComAux	ComPrn	ComPC

ComPC: data transmission/reception to PC/PLC, printer, repeater.

ComPrn: data transmission to printer, repeater

ComAux: data transmission/reception to printer, repeater, reception remote scale, barcode reader.

!! IMPORTANT !!

THE CONNECTION AND THE SOFTWARE CONFIGURATION OF THE SERIAL PORTS MUST BE MADE BY TECHNICAL PERSONNEL WHO KNOWS THE PROCEDURES ON THE BASIS OF THE USER'S NEEDS.

The data transmission cable must be kept away from the AC power supply lines.

!! REMOVE VOLTAGE BEFORE OPENING THE INSTRUMENT !!

THE STANDARD CONFIGURATION OF THE SERIAL PORTS IS THE FOLLOWING:

Baud rate = 9600, Parity = None, Data word = 8, Stop bit = 1, CTS signal = No Cts. The configuration may be modified in the SET-UP environment in the << **Serial** >> step.

8.1 RS 485 CONNECTION

Below is the RS485 connection of the indicator in the CoM3:

Meaning	Indicator Serial line
TX-/RX-	22 A(+)
TX+/RX+	23 B(-)

On the same RS 485 line it's possible to connect up to 32 devices, among indicators, digital load cells, 485/232 signal converter.

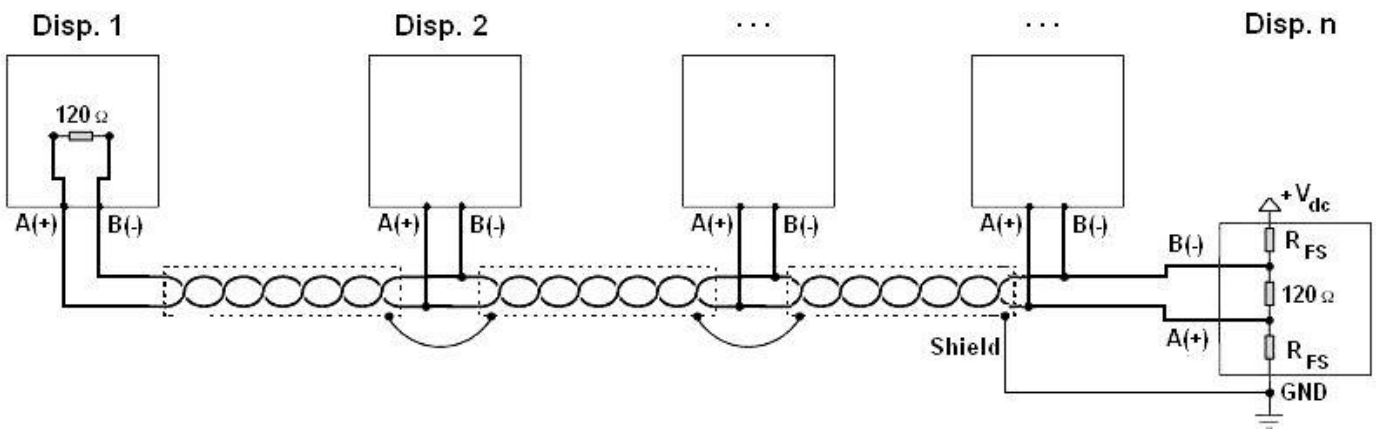

Figure 1: electrical diagram of RS485 connections.

- Use a **STP** (Shielded Twisted Pair) cable in order to make the connection (twisted and shielded pair/s with single shielding for each pair through aluminium band and total shielding through external sheathing).

The maximum reachable length from the line with the use of the appropriate cable for RS 485 connections, the twisted 2x24 AWG duplex cable, shielded with external sheathing + aluminium band, is of about 1200 meters (see section "MAXIMUM CABLE LENGTH").

- With very long cables, the cable capacity (normally near 50pF/m) starts being a dominant factor in the power consumption and increases with the increase of speed.

This implies that **the maximum distance can not be covered with the maximum possible speed.** For an approximate value, one can consult the following table:

Baud rate	Total capacity of the cable (pF)
1200	400000
2400	200000
4800	100000
9600	50000
19200	25000
38400	12000
57600	8000
115200	4000

As a general rule, if one has any doubts, it is always preferable to **choose the cable with a greater section.**

- Verify that the grounding satisfies the requirements of section "EARTHING SYSTEM". Especially, all the digital masses, as well as the analogue masses, and the power circuits, must be connected to the grounding bar and this last one must be connected to the grounding pole.
- The shielding can be connected into a single point of the entire network (as shown in Figure 1) or both its ends, however it's important that **all the masses have the same potential**, in order to avoid the forming of current rings.
- On the RS485 network normally one connects 2 **termination resistances** equal to the characteristic impedance of the cable (typically 120 Ω, see Figure 1), **ONLY** on the 2 devices **which are at the 2 ends of the cable**. The terminal resistance is not supplied with the ports of the indicator.
- The difference of potential between the A(+) and B(-) terminals in rest conditions (for example with instrument in set-up phase), **must be of at least 0,2 V**.
To create a resistive divider which maintains this difference of potential also when all the transmitters are disabled, inert in the RS485 port of the indicator where there are the termination resistances, the **polarisation** or **fail-safe resistences** (R_{FS} in Figure 1). The value of these resistances is between 390 Ω and 2,2 kΩ.

NOTE: in particular, the value of each of these resistances must be greater than the value calculable through the formula:

$$R_{FS} = \frac{R_{eq}}{2} \times \left(\frac{V_{dc}}{0,2} - 1 \right)$$

in which:

- V_{dc} is the power supply voltage of the line
- R_{eq} is the overall resistance to the A(+) a B(-) heads, supplied by the parallel of the 2 termination resistances and all the input resistances of the devices connected to the bus.

FOR EXAMPLE:

Presuming that a connection has 120 Ω as termination resistance and 32 connected devices, each having an input impedance of 12 kΩ. The V_{dc} power supply is 5 V.

One calculates R_{eq} , equal to about 52 Ω, and R_{FS} which must be at least equal to 624 Ω.

- **The connection between the indicator and the digital load cells is made with RS485 protocol in the COM3 configured as CoMAuX.** The indicator can be connected with up to 16 digital load cells.
- It's possible to connect the indicator to digital load cells with 485 4-wire protocol through 422/232 converter. In this case one is required to connect the double TX of RS422 cable to TX+ and TX- converter's pins and the double RX of RS422 cable to RX+ and RX- converter's pins
- In case of connection with non Dini Argeo devices, there may be different ways of line marking: generally one presumes that the A/B indication corresponds to the +/- and HI/LO markings, but this is not always true. Therefore, if the device does not function, one should try inverting the connections even if everything seems to be correct.

For the correct functioning of the digital load cells, one should, in any case respect all the rules given in the relative specific manuals.

8.2 PC CONNECTION

9 PIN CONNECTOR

INDICATOR	9 pin Collector	Color
TX	2	Pink
RX	3	Yellow
GND	5	Grey

8.3 PRINTER CONNECTION

INDICATOR	WTY280 /SMT80 9pin (female)	TMU295 /LX300 25pin (female)	LP542 Plus /TTP243/SMTPLUS 9pin (female)	Standard cable
TX	3	3	3	Pink
CTS	4	20	8	Brown
GND	7	7	5	Grey

TPR	STANDARD CABLE	INDICATOR
GND	Black	GND
CTS	Yellow	CTS
RX	Grey	TX

TPR printer power supply		
	STANDARD CABLE	Terminal box
+VP e +VC	Red and Orange	5 Vaux
GND e GND	Black and Black	16 GND

8.4 TRANSMISSION PROTOCOLS

STANDARD

[available for ComPc, ComPrn, ComAux]

The weight data transmission on the serial port happens in the following format:

[CC]HH, KK, P P P P P P P P, U M <CR LF>

in which:

[CC] = instrument code, es.00 (only with RS485 protocol)

HH = UL Underload
OL Overload
ST Weight stability
US Weight instability

, Comma character

KK = NT Net Weight
GS Gross Weight

, Comma character

P P P P P P P P = Weight (8 digits including the possible sign and decimal point)

, Comma character

UM = Unit of measure (Kg, g, t, lb)

<CR LF> Carriage Return + Line Feed (ASCII Characters 13 and 10)

AFOX STRING

[available for ComPc]

The weight data transmission on the serial port happens in the following format:

CC[**SS**,**B**,**LLLLLLLLLLLLLUM**,**YYTTTTTTUM**<**CR LF**>

in which: **[CC]** = instrument code, es.00 (only with RS485 protocol)

SS UL Underload
OL Overload
ST Weight stability
US Weight instability

, Comma character

B Scale Number

, Comma character

LLLLLLLLLLL Gross weight (10 digits including the possible sign and decimal point).

UM = Unit of measure (Kg, g, t, lb)

, Comma character

YY - 2 spaces if the tare is automatic, or
- PT if a tare is pre-set or set manually

TTTTTTTTTT Tare weight (10 digits including the possible sign and decimal point).

UM = Unit of measure (Kg, g, t, lb)

<**CR LF**> Carriage Return + Line Feed
(ASCII 13 and 10)

DINI ARGEO REPEATER

[available for ComPc, ComPrn, ComAux]

Transmission protocol for connection to a Dini Argeo weight repeater. It transmits the weight value shown on the LED display to the Dini Argeo weight display.

In this case, the setting of the **PC.Mode** "TRANSMISSION TYPE" parameter has no relevance.

LCD REPEATER

[available for ComPc]

With this transmission protocol, it is possible to repeat the messages shown on the LCD display.

The data is transmitted in the following format:

XX + CR + LF

In which:	XXXXXXXXXXXXXXXXXXXX	=	<u>Data shown on the first line of the LCD display</u>
	YYYYYYYYYYYYYYYYYY	=	<u>Data shown on the second line of the LCD display</u>
	CR	=	Carriage Return
	LF	=	Line Feed

MONODIRECTIONAL

[available for ComPc]

Through this communication protocol the serial command management is excluded, in order to avoid possible responses to data received from the port in case of use of the 485 serial line; it can be useful when one uses the port for transmitting a printout, and various devices are connected on the same 485 line. With this protocol the data and serial command reception is disabled.

ALIBI MEMORY

[available for ComPc, ComPrn]

Should set this parameter in order to store the weighs acquired automatically or manually using the print key (F5) and the totalization key(F6); see the protocol specifications in the "ALIBI MEMORY" section in the user manual.

Furthermore, by enabling the protocol on ComPC, a string will be transmitted containing the stored weight data.

NOTE: in the ComPrn the string will not be transmitted.

NO PROTOCOL

[available for ComAux]

Set in case of connection to remote scale or badge / bar code reader (serial ports).

“PRINT”

[disponibile per ComPrn]

The weight data transmission on the serial port depends on the print functions of the indicator.

For further details see section “PROGRAMMING THE PRINTOUTS” and section “PRINTOUTS” **USER MAN.REF.**

8.5 TRANSMISSION MODES

Data transmission from PC Serial Port can be done in **4** different ways:

TRANSMISSION ON REQUEST

[available for ComPc]

It requires an external command from the PC to send the data requested. Transmission can take place at any time requested.

CONTINUOUS TRANSMISSION

[available for ComPc, ComPrn, ComAux]

- ComPc: Continuous transmission of the standard string (**Protoc. = StAnd** step) or of the extended AF0X string (**Protoc. = AF0X** step) or continuous transmission of the customised string.

This mode is used for interfacing to the computer, remote displays, and other devices which require a constant update of the data independently from the weight stability (10 transmissions per second with a Baud rate at 9600 and stable weight).

- ComPrn: The indicator transmits continuously the data configured in the 01 print format.

Alternatively, by setting only the “300” block in the 01 print format, it is possible to transmit the STANDARD STRING (or the AF0X STRING, if configured for the PC port).

For configuration details of the print formats, see section “PROGRAMMING THE PRINTOUTS”.

- ComAux: The weight transmission on the serial port takes place with the STANDARD protocol.

TRANSMISSION ON STABILITY

[available for ComPc]

Transmission is automatic each time the weight put on the platform reaches stability (“~” pilot light off); the minimum transmission limit is of 10 divisions with a NON APPROVED instrument and 20 divisions with an APPROVED instrument. The reactivation of the transmission takes place depending on how the **F.Mode >> react** “REACTIVATIONS” parameter of the SET-UP environment has been set (passage by zero of the net weight or weight instability).

RS485 TRANSMISSION

[available for ComPc]

On Com3 is available a RS485 Half Duplex serial output, enabling the possibility of bi-directional communication up to 63 indicators to just one computer.

The transmission protocol is the same as that of transmission upon request, with the adding of a code that identifies the weight indicator (i.e. “00READ <CR LF>”).

8.6 SERIAL COMMANDS FORMAT**LEGEND**

[CC]= instrument code, i.e.. 00 (only with 485 protocol).

<CR LF>= Carriage Return + Line Feed (ASCII 13 and 10 characters).

SERIAL PORT ERRORS

With each serial command received, the instrument transmits a string containing the response (see the command description) or one of the following indications:

OK<CR LF> is shown when one transmits a correct command to the indicator. The OK response does not imply that the instrument executes the command.

ERR01<CR LF> is shown when one transmits a correct command to the indicator followed however by letters entered by mistake (I.E.: READF TARES...).

ERR02<CR LF> is shown when one transmits a correct command to the indicator containing the wrong data.

ERR03<CR LF> is shown when one transmits a command not allowed by the indicator. It can be a command not used in the selected functioning mode, or the command reaches the indicator in the instant in which the keyboard buffer is already occupied by another command.

ERR04<CR LF> is shown when one transmits an inexistent command.

NOTA: The instrument does not transmit any indication to brief commands, in other words, ones made up by one single letter plus an eventual parameter.

COMMANDS

<u>Version reading:</u>	[CC]VER<CR LF>
Instrument response :	[CC]VER,vvv,E-CHECKb<CR LF>
In which:	vvv is the firmware version
<u>Data reading:</u>	[CC]READ<CR LF> or: [CC]R<CR LF>
Instrument response:	see Transmission Protocol
<u>Tare:</u>	[CC]TARE<CR LF> or: [CC]T<CR LF> [CC]TAREB<CR LF>

NOTE: The response of TAREB is “OK” if the command has been carried out correctly, while it will be “KO”, if it hasn’t. The TARE and T commands gives an “OK” positive response for just the reception, without considering its outcome.

<u>Fixed tare command:</u>	[CC]WTTTTTT<CR LF> [CC]TMANTTTTTT<CR LF>
In which:	W/TMAN= command TTTTTT = tare in ASCII, max 6 characters Example: W10.0 <CR LF>

<u>Zero:</u>	[CC]ZERO<CR LF> or [CC]Z<CR LF> [CC]ZEROB<CR LF>
---------------------	---

NOTES:

- The response of ZEROB is “OK” if the command has been carried out correctly, while it will be “KO”, if it hasn’t. The ZERO and Z commands gives an “OK” positive response for just the reception, without considering its outcome.
- If executed during the weighing cycle, it starts the automatic zero procedure of the belt, at the end of the weigh eventually under way (see section “WEIGHING BELT AUTOZERO”, **USER MAN.REF.**).

<u>Clear:</u>	[CC]CLEAR<CR LF> or [CC]C<CR LF>
----------------------	---

<u>Net/Gross change:</u>	[CC]NTGS<CR LF>
---------------------------------	------------------------------

<u>Print:</u>	[CC]PRINT<CR LF> or [CC]P<CR LF> [CC]PRNTB<CR LF>
----------------------	--

NOTE: The response of PRNTB is “OK” if the command has been carried out correctly, while it will be “KO”, if it hasn’t. The PRINT and P commands gives an “OK” positive response for just the reception, without considering its outcome.

Reading of the executed weigh

[CC]CIP,1<CR><LF>

Instrument answer:

@2,NN,PPPPPPPPUM,c,CCC<CR><LF>

in which:	@2:	identifying code of the answer
	NN:	number of last totalised weigh (weigh number of the lot total)
	PPPPPPPP:	last totalised NET weight
	UM:	unit of measure of the scale
	CCC:	calculated checksum

The command is updated with each totalised weigh; therefore until a new weigh is totalised, the instrument will respond with the last available one.

Weigh reading:

Instrument answer:
in which:

[CC]REXB<CR LF>

[CC]BBSSNNNNPPTTTT PPPMMMMKK

[CC] 485 address in ASCII

BB: Number of active channel

SS: UL Underload

OL Overload

ST Weight stability

US Weight instability

TTTT: Net weight (Big endian).

NNNN: Net weight (Big endian).

PP: 0- if semiautomatic tare

1- if manual tare

KK: CRC checksum like Modbus

Reading of net weight with sensitivity times 10:

Instrument's answer:
In which:

[CC]GR10<CR LF>

[CC]SS,GX,VVVVVVVVV,UM<CR LF>

SS:

UL Underload

OL Overload

ST Stability of the weight

US Instability of the weight

GX Weighing times 10 status

VVVVVVVVV Value of net weight times 10 (10 characters)

UM Unit of measure (Kg, g, t, lb)

NOTE: The instrument does not transmit the OK answer to the short commands (R, T, Z, P....).

Modification of GR10 command response:

in which:

[CC]GR10X<CR LF>

GR10= command

X → E enabled

X → D disabled

Example: GR10E<CR LF>

If enabled, it modifies the format of the GR10 command response string: it responds to the GR10 command with the number of the active scale in the place of the "GX – weighing status x 10").

The setting is valid when the indicator is turned off. To save it permanently in the instrument one should transmit the command in the set-up status.

AFX type string reading and scale information:**[CC]RALL<CR LF>**

Instrument answer:

[AFX string] B,NNNNNNNUM,LLLLLLLUM,PPPPPPN,SSS,AAA,CCC,TTT,XXXXX-YYYYYY.

in which:

B Number of platform on which the totalisation has been made.

NNNNNNNUM Last net weight totalized with unit of measure.

LLLLLLLUM Last gross weight totalized with unit of measure.

PPPPPPP Last pieces totalized.

SSS Scale status: 000 start-up

001 weighing

002 selection of functioning mode

003 generic menu

004 set-up menu

005 user menu

006 exit from set-up

007 Update Firmware status

008 setting of user default

009 setting of technical default

010 switch channel
 011 setting of technical default
 012 Test of the PC serial ports
 013 Test of the PRN serial ports

AAA Counter of pressed keys.
 CCC Code of last key pressed.
 TTT Counter of totalisations.
 XXXXX Last rewriting number stored in the Alibi memory.
 YYYYYY Last weigh number stored in the Alibi memory.

9. ANALOGUE OUTPUT (OPTIONAL)

Through an optional interface, it is possible to use an analogue output configurable at 0 – 10V, 0 – 20 mA or 4 – 20 mA. The voltage and the output current from the interface are proportional to the gross or net weights on the scale or take on the value configured in the active article.

In regards to the electrical connection scheme, see section “ELECTRICAL SCHEMES”.

9.1 OPERATING MODES

9.1.1 OUTPUT ON THE GROSS WEIGHT

The value of the analogue output grows proportionally to the gross weight on the scale in relation to the configured value for the gross weight at 0 (AO ZE), and the one configured for the gross weight equal to the capacity (AO MA).

When the gross weight is equal or greater than the capacity, the output takes on the value set for AO MA, while in the underload condition (gross weight \leq -100d with approved instrument) the output takes on the value set for AO MI.

Trend examples (approved instrument)

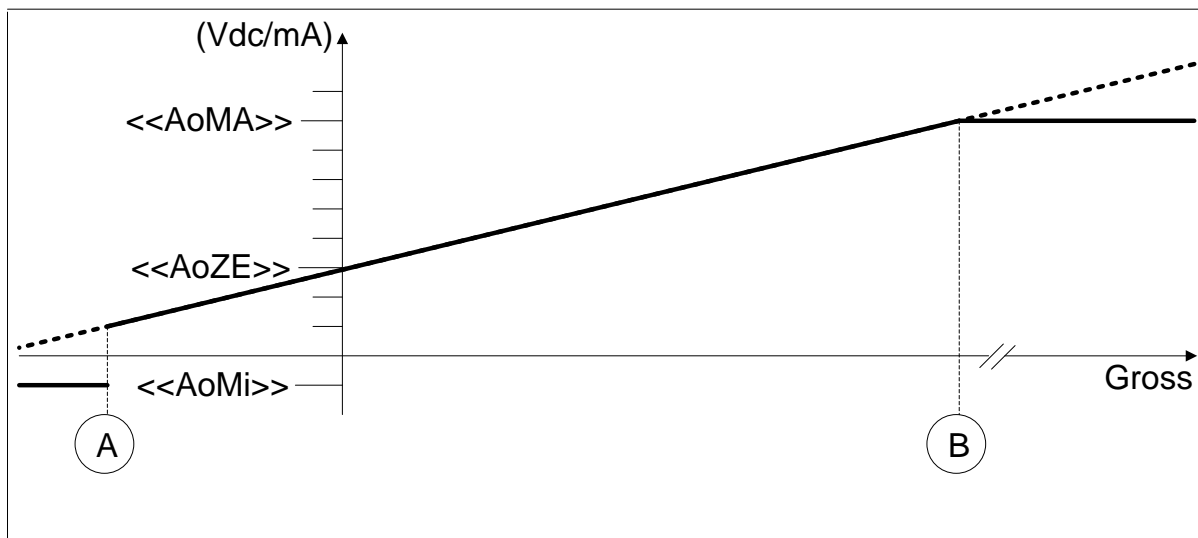
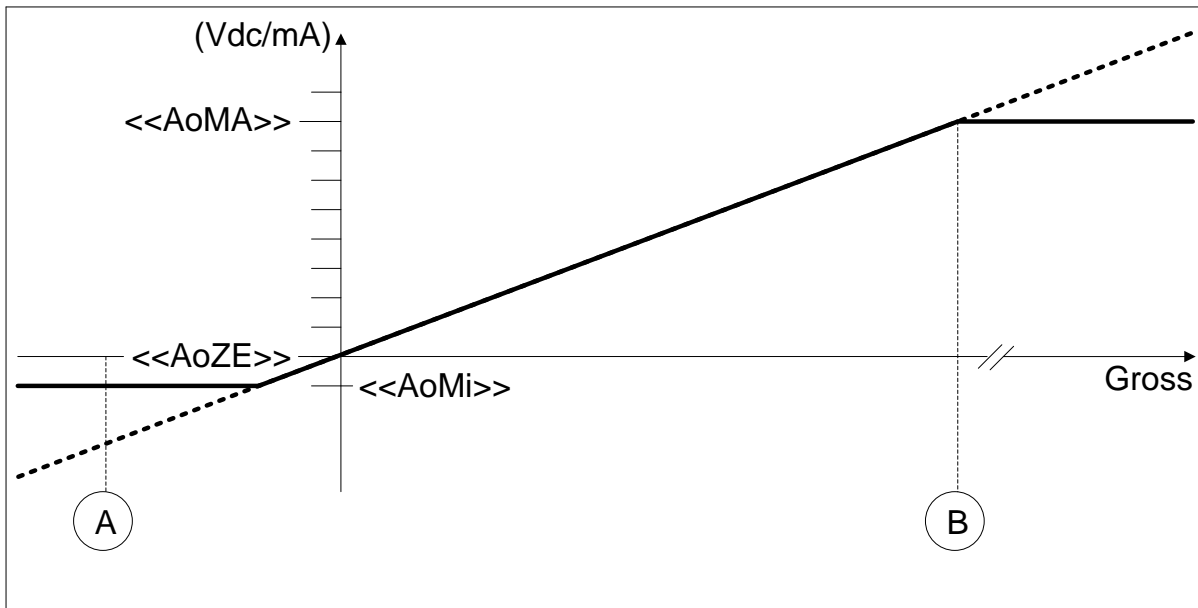

A Gross = -100d

B Gross = Max Capacity

9.1.2 OUTPUT ON THE NET WEIGHT

The value of the analogue output grows proportionally to the net weight on the scale in relation to the value configured for the net weight at 0 (AO ZE), and the one configured for the net weight equal to the capacity (AO MA).

When the gross weight is equal or greater than the capacity + 9e, the output takes on the value set for AO MA, while in the underload condition (gross weight \leq -100d with approved instrument) the output takes on the value set for AO MI.

Trend examples (approved instrument)

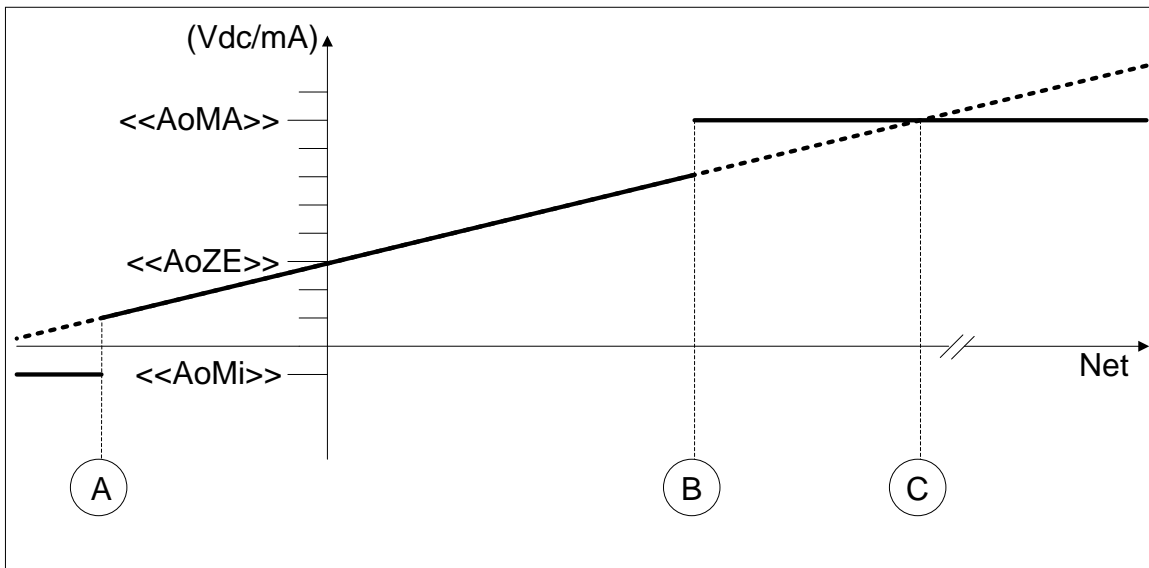
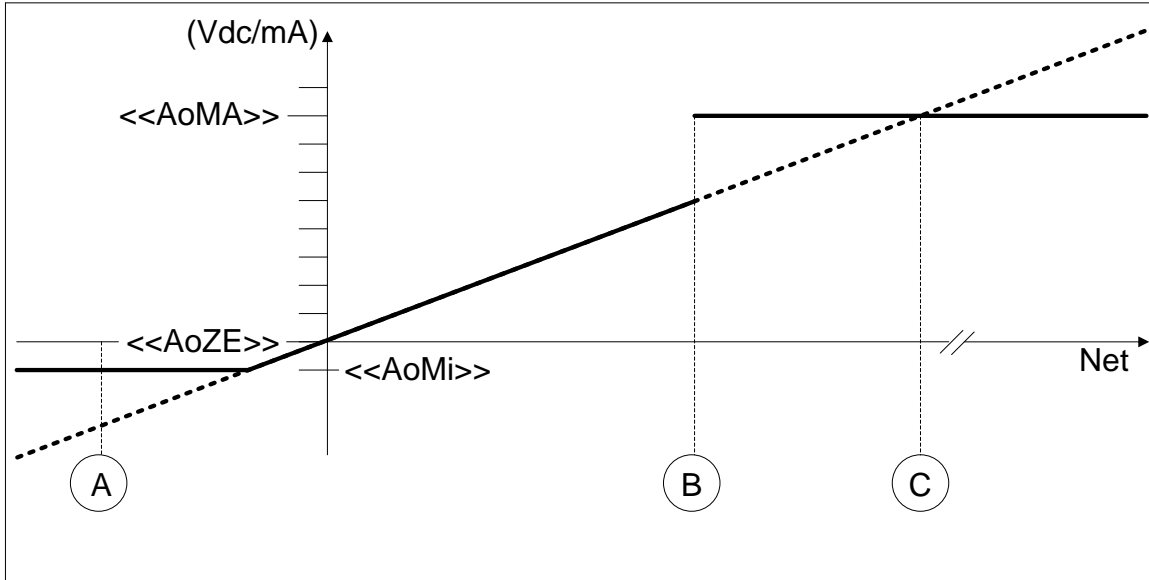

- (A) Gross = -100d
- (B) Gross = Max capacity + 9e
- (C) Net = Max capacity

9.1.3 OUTPUT WITH VALUE FROM THE ARTICLE FOR THE BELT SPEED MANAGEMENT

At start up or at article selection, the output voltage or current of the interface takes on the programmed value in the active article (see section "ARTICLES DATABASE", **USER.MAN.REF**), till an article with a different value is selected.

Therefore, in order to manage the analogue output, one has to manage the article database, by enabling the tolerance check function (see $\llcorner\llcorner\text{TST.TOL}>>$ step) and the check type with article (see $\llcorner\llcorner\text{CHECK.t}>>$ parameter).

9.2 CONFIGURATION

In order to configure the parameters, one needs to enter in the << **ANOUT** >> step:

<< **SLOT** >> SLOT SELECTION

One selects the SLOT to be used with the analogue output: SLOT 1 or SLOT2; it is possible to indifferently use either SLOT.

<< **MODE** >> OPERATING MODE

AO G = analogue output on gross weight

AO N = analogue output on net weight

AO.BELT = analogue output with article value for the belt speed management.

Once the functioning mode on gross or net weight is confirmed, one sets the values of the analogue output useful in the weighing phase for the calculation of the value that the output must take on proportionally; in other words, the digital/analogue converter values are entered (between 0 and 65535) to which corresponds a certain output value in voltage or in current.

In this configuration the instrument keys take on the following meanings (functions):

ENTER By pressing once after a value is entered, it activates the corresponding output analogue value, (allowing the check) but the step still remains inside in case of a new modification. By pressing a second time (on the same entered value) it confirms and exits the step.

C Allows to quickly zero the present value.

NUMERICAL KEYS Allow to enter values, from right to left.

<< **AOMA** >> MAXIMUM VALUE

By entering this step, one sets the maximum value of the analogue output, in other words the corresponding value of the full scale capacity. This value can be anywhere between 0 and 65535 (values of the digital/analogue converter); if a higher digit is entered, the instrument emits a prolonged sound, after which it zeros the value just entered.

<< **AOZE** >> SCALE ZERO VALUE

By entering this step, one sets the analogue output value when the scale displays zero weight. This value can be anywhere between 0 and 65535 (values of the digital/analogue converter); if a higher digit is entered, the instrument emits a prolonged sound, after which it zeros the value just entered.

<< **AOMI** >> MINIMUM VALUE

By entering this step, one sets the minimum value of the analogue output. This value can be anywhere between 0 and 65535 (values of the digital/analogue converter); if a higher digit is entered, the instrument emits a prolonged sound, after which it zeros the value just entered.

APPROXIMATE VALUES BETWEEN THE D/A CONVERTER AND ANALOGUE OUTPUT

D/A CONVERTER VALUES	VOLTAGE VALUE (V)	CURRENT VALUE (mA)
1070	0	
1240		0
11500		4
52500		20
62450	10	

10. PROGRAMMING THE PRINTOUTS

It is possible to programme 30 different print formats, linked to the 12 available print functions (see section “PRINTOUTS”, **USER.MAN.REF.**):

- “Prn.F.1” format >> simple printout
- “Prn.F.2” format >> totalization within tolerance
- ...

For the complete list of the functions and the linked formats, see the “PRINTOUTS” section of the **USER MANUAL**.

It is possible to configure the formats:

- **through the Dinitools™ software** for PC, and transmitted to the indicator through the serial line; it is necessary that the print format number (“Print Format Number”) is a value between 1 and 11 to indicate the format to be overwritten.
- **manually from the indicator** by entering in the **Setup >> Serial** step inside the SET-UP environment.

MANUAL CONFIGURATION OF THE PRINT FORMATS

Each ticket is made up of a maximum of 2048 memory storages (which we will call “lines”, from 0 to 2047; only the first 1000 are manually modifiable from the indicator), which, when programmed, these will produce the desired printout; in each line one can enter (through a 3-digit code, from 300 onwards) a command named “print block”, which will produce a certain type of printout, for example:

PRINT NET WEIGHT (code 307), which will print the net weight value, the unit of measure and the CR or CR LF to go to the next line.

Or it is possible to print a single alphanumeric character, entering the relative ASCII code in the line (from 0 to 255).

To configure a print format:

- Enter in the **Setup >> Serial** parameter.
- Scroll the steps through the arrows keys ▲ ▼ until the format to be configured, is selected; the display shows:

c.F.X in which:

X indicates the number of the format to be modified (from 01 to 11)

- Press the **ENTER** key
- Once entered in a format (for example Prn.F.1), the display shows:

XXX.YYY in which:

XXX is number of the line which one is programming.

YYY is the entered code (from 0 to 255 the ASCII code is printed, from 300 onwards the relative block is printed).

- Select the line to be programmed using the arrow keys ▲ ▼ , or by typing the line number through the numeric keyboard, and press the **ENTER** key.
- The display shows “CHANGE” for an instant and onwards:

XXX in which:

XXX is the value to be modified.

- Enter a value and press the **ENTER** key to confirm; the **C** key clears the entered value and if pressed again it cancels the operation.
- If a print block with parameters from 600 onwards has been entered, after having pressed the **ENTER** key the displays shows:

XXX in which:

XXX is the value to be modified.

- Enter a valid value and press the **ENTER** key to confirm.
- Once programmed all the desired lines one should enter in the last line block 300 (PRINT END); Press the **C** key to exit; the display will show the saving request; press the **ENTER** key to confirm or another key to cancel.

KEYS' FUNCTIONS

- ▲ scrolls forward inside the lines of the print format.
- ▼ scrolls backward inside the lines of the print format.
- F1** enters a print block or an ASCII character in the selected line moving the consecutive blocks of one place;
- F2** cancels the current line compacting the blocks that follow.
- F3** enters a print end in the current line.
- ENTER** modifies the code in the current line; while entering it confirms the entered code.
- C** exits the programming; if a format has been modified, one is asked to save (the display shows "SAVE?"); with **ENTER** one confirms, with another key one exits without saving. While entering a code, it quickly zeros the present value.

NUMERICAL

KEYBOARD allows entering a code inside of the selected printing line.

HELP

By pressing the **./HELP** key, it's possible to see the keys list used in the menu.

The key list is automatically. If you want to see the keys list, in manual mode, use the arrow key (F6 ▼ e F7 ▲).

NOTES

- For the complete list of the ASCII codes and the print blocks, see the sections "ASCII CODE TABLE" and "LIST OF PRINT BLOCKS".
- To terminate the programming of a format, it is necessary that the last command be "Print end": one should enter the code 300 (or press the **F3** key) in the last line of the format.

PRINTING ON THE PC SERIAL PORT

By programming correctly a ticket, it is possible to direct the printing on the PC serial port, and then bring it back onto the printer port.

The correct syntax in the ticket is the following:

- **312 PRINTS ON PC PORT**

- prints block or ASCII character
- ...

- **314 FORCES PRINTING**

- **313 PRINTS ON PRINTER PORT**

- prints block or ASCII character
- ...

- **314 FORCES PRINTING**

- **300 PRINT END**

The "Forces print" block executes the transmission of all the blocks or ASCII characters entered BEFORE the same block; reading block 312, the printout is directed onto the PC port.

All the blocks or ASCII characters entered here are instead transmitted through the printer serial port.

10.1 PROGRAMMING EXAMPLE

Programming the ticket of the PRINT key (empty) in this way:

MARIO ROSSI SRL	MARIO ROSSI SRL
Date – time	1/02/2005 – 19:00:00
Gross weight	GROSS 2.000kg
Tare weight	TARE 0.000kg
Net weight	NET 2.000kg
3 CRLF	
Print end	

After having entered in the SET-UP environment, follow the procedures below:

- Move to the << **Prn.F.1** >> step inside the << **Serial** >> parameter of the “SET-UP” step and press **ENTER**: the display shows “**0.XXX**” (in other words the block set in the first line).
 - Press **ENTER**; the display shows for an instant “**ChAnGE**” and then “**XXX**” (the last digit on the right blinks): enter the 077 code (ASCII relative to the letter “M”), confirm with **ENTER**.
 - The display now shows “**1.XXX**” (in other words, the block set in the second line), press **ENTER** and enter the 065 code (ASCII relative to the letter “A”); confirm with **ENTER** to go to the third line.
 - repeat the same operations entering the following codes:
 - 082 (letter “R”)
 - 073 (letter “I”)
 - 079 (letter “O”)
 - 032 (space)
 - 082 (letter “R”)
 - 079 (letter “O”)
 - 083 (letter “S”)
 - 083 (letter “S”)
 - 073 (letter “I”)
 - 329 (prints date – time)
 - 302 (prints gross weight)
 - 301 (prints net weight)
 - 303 (prints tare weight)
 - 300 (print end)
- ** It is possible to enter the print end also with the F3 key ****

- Press the **C** key to exit the programming: the display shows “SAVE?”, confirm with **ENTER** (one goes back into the “SERIAL” parameter).

- Exit the SETUP environment of the instrument by pressing the **C** key three times: the display shows “SAVE?”, confirm the changes made with **ENTER** (the instrument returns to weighing).

10.2 ASCII CODE TABLE

Dec	Hex	Char	Dec	Hex	Char	Dec	Hex	Char	Dec	Hex	Char
0	00	Null	32	20	Space	64	40	@	96	60	`
1	01	Start of heading	33	21	!	65	41	A	97	61	a
2	02	Start of text	34	22	"	66	42	B	98	62	b
3	03	End of text	35	23	#	67	43	C	99	63	c
4	04	End of transmit	36	24	\$	68	44	D	100	64	d
5	05	Enquiry	37	25	%	69	45	E	101	65	e
6	06	Acknowledge	38	26	&	70	46	F	102	66	f
7	07	Audible bell	39	27	'	71	47	G	103	67	g
8	08	Backspace	40	28	(72	48	H	104	68	h
9	09	Horizontal tab	41	29)	73	49	I	105	69	i
10	0A	Line feed	42	2A	*	74	4A	J	106	6A	j
11	0B	Vertical tab	43	2B	+	75	4B	K	107	6B	k
12	0C	Form feed	44	2C	,	76	4C	L	108	6C	l
13	0D	Carriage return	45	2D	-	77	4D	M	109	6D	m
14	0E	Shift out	46	2E	.	78	4E	N	110	6E	n
15	0F	Shift in	47	2F	/	79	4F	O	111	6F	o
16	10	Data link escape	48	30	0	80	50	P	112	70	p
17	11	Device control 1	49	31	1	81	51	Q	113	71	q
18	12	Device control 2	50	32	2	82	52	R	114	72	r
19	13	Device control 3	51	33	3	83	53	S	115	73	s
20	14	Device control 4	52	34	4	84	54	T	116	74	t
21	15	Neg. acknowledge	53	35	5	85	55	U	117	75	u
22	16	Synchronous idle	54	36	6	86	56	V	118	76	v
23	17	End trans. block	55	37	7	87	57	W	119	77	w
24	18	Cancel	56	38	8	88	58	X	120	78	x
25	19	End of medium	57	39	9	89	59	Y	121	79	y
26	1A	Substitution	58	3A	:	90	5A	Z	122	7A	z
27	1B	Escape	59	3B	;	91	5B	[123	7B	{
28	1C	File separator	60	3C	<	92	5C	\	124	7C	
29	1D	Group separator	61	3D	=	93	5D]	125	7D	}
30	1E	Record separator	62	3E	>	94	5E	^	126	7E	~
31	1F	Unit separator	63	3F	?	95	5F	_	127	7F	□

Dec	Hex	Char	Dec	Hex	Char	Dec	Hex	Char	Dec	Hex	Char
128	80	Ç	160	A0	á	192	C0	Ł	224	E0	α
129	81	ù	161	A1	í	193	C1	ł	225	E1	β
130	82	é	162	A2	ó	194	C2	Ṭ	226	E2	Γ
131	83	â	163	A3	ú	195	C3	ł̇	227	E3	π
132	84	ä	164	A4	ñ	196	C4	—	228	E4	Σ
133	85	à	165	A5	Ñ	197	C5	†	229	E5	σ
134	86	ã	166	A6	ª	198	C6	‡	230	E6	μ
135	87	ç	167	A7	º	199	C7	‡	231	E7	τ
136	88	ê	168	A8	¿	200	C8	Ł	232	E8	φ
137	89	ë	169	A9	ƒ	201	C9	ƒ	233	E9	θ
138	8A	è	170	AA	¬	202	CA	Ł	234	EA	Ω
139	8B	ì	171	AB	½	203	CB	ƒ	235	EB	δ
140	8C	î	172	AC	¼	204	CC	‡	236	EC	∞
141	8D	ï	173	AD	;	205	CD	=	237	ED	∞
142	8E	Ä	174	AE	«	206	CE	‡	238	EE	ε
143	8F	Å	175	AF	»	207	CF	Ł	239	EF	∏
144	90	É	176	B0	⋯	208	DO	Ł	240	FO	≡
145	91	æ	177	B1	⋮	209	D1	ƒ	241	F1	±
146	92	Æ	178	B2	⋭	210	D2	π	242	F2	≥
147	93	ô	179	B3		211	D3	Ł	243	F3	≤
148	94	ö	180	B4	†	212	D4	Ł	244	F4	[
149	95	ò	181	B5	‡	213	D5	ƒ	245	F5]
150	96	û	182	B6	‡	214	D6	ƒ	246	F6	÷
151	97	ù	183	B7	π	215	D7	‡	247	F7	≈
152	98	ÿ	184	B8	ƒ	216	D8	‡	248	F8	°
153	99	Ö	185	B9	‡	217	D9	∟	249	F9	•
154	9A	Û	186	BA		218	DA	ƒ	250	FA	·
155	9B	◊	187	BB	π	219	DB	■	251	FB	√
156	9C	£	188	BC	Ł	220	DC	■	252	FC	∂
157	9D	¥	189	BD	Ł	221	DD		253	FD	z
158	9E	℔	190	BE	∟	222	DE		254	FE	■
159	9F	f	191	BF	∟	223	DF	■	255	FF	□

10.3 LIST OF PRINT BLOCKS

LEGEND:

- b** indicates a space character (ASCII 32 decimal character).
UM unit of measure of the active scale (kg, **bg**, **bt**, lb).
UMD unit of measure of the database (kg, **bg**, **bt**, lb).
+ T terminator: depending on the setting of the << **tErMin** >> step, a CR or CRLF is added, or no terminator.
XXX* These blocks do not work without the alibi memory (optional).

The weight fields expand from right to left, with spaces (ASCII 32 decimal character) to complete the field length.

10.3.1 ORDER BY KIND

CODE	GENERIC	PRINT FORMAT
300	PRINT END	
310	DOTTED LINE	----- + T
311	DATE / TIME FOR DP24/DP190 the date and time of the printer is printed; one can adjust it through the printer.	b HH:MM b DD-MM-YY + T
312	PRINTS ON PC PORT	
313	PRINTS ON PRINTER PORT	
314	FORCES PRINTOUT	
360	DATE INDICATOR	DD-MM-YY + T
361	TIME INDICATOR	HH:MM + T
362	DATE TIME INDICATOR	HH:MM b DD-MM-YY + T
363	FOLLOWING MACRO TERMINATOR SKIPS	
364	HEADING 1	XXXXXXXXXXXXXXXXXXXXXXXXX + T
365	HEADING 2	XXXXXXXXXXXXXXXXXXXXXXXXX + T
366	HEADING 3	XXXXXXXXXXXXXXXXXXXXXXXXX + T
	in which XXXXXXXXXXXXXXXXXXXX are the 24 characters of the first line of the heading; just the entered characters are printed, from left to right.	
370	ACTIVE SCALE NUMBER in which X is the active scale number (1..4)	SCALE b NUMBER b X + T
371	JUST ACTIVE SCALE NUMBER	X
372	SCALE UNIT OF MEASURE	UM + T
373	DATABASE UNIT OF MEASURE	UM + T
439	STANDARD KD PROTOCOL STRING	
440	AFX PROTOCOL STRING By using blocks 439 and 440 it is possible to print the STANDARD or AFX serial string (see section "TRANSMISSION PROTOCOLS" for the description); the string terminator is the one set in the tErMin "SET TERMINATOR TYPE" step in the SET-UP environment (CR or CRLF or no terminator).	
528	PRINT TERMINATOR	CR, CRLF, LF o NOT TERMINATOR
529	PRINT OF CALCULATED DATA	XXXXXXXXXX
530	PRINT OF ENTERED DATA	XXXXXXXX
531	PRINTS SECOND ENTERED DATUM	XXXXXXXX
532	PRINTS OPERATION SYMBOL " + " in case of addition, " - " in case of subtraction, " x " in case of multiplication.	X

The 529, 530, 531 and 532 blocks refer to the operation executed with the "calculator" function described in section "CALCULATOR", **USER MAN.REF.**

WEIGHT		
301	JUST NET WEIGHT	XXXXXXXXXX
302	JUST GROSS WEIGHT	XXXXXXXXXX
303	JUST TARE WEIGHT	XXXXXXXXXX
307	NET WEIGHT in which XXXXXXXXXXXX is the weight value on 10 digits including the comma.	NET bbb =bXXXXXXXXXXXXUM + T
308	GROSS WEIGHT	GROSS=bXXXXXXXXXXXXUM + T
309	TARE WEIGHT	TARE b =bXXXXXXXXXXXXUM + T
367	JUST GROSS ON 10 DIGITS	XXXXXXXXXX
368	JUST NET ON 10 DIGITS	XXXXXXXXXX
369	JUST TARE ON 10 DIGITS the field expands from right to left with many spaces for completing the field length.	XXXXXXXXXX
PARTIAL TOTAL		
377	JUST PARTIAL NET TOTAL	XXXXXXXXXX
378	JUST TEXT PARTIAL NET TOTAL	NET bb PART.T.
379	PARTIAL NET TOTAL	NET bb PART.T.XXXXXXXXX b UMD+T
386	JUST PARTIAL GROSS TOTAL	XXXXXXXXXX
387	JUST TEXT PARTIAL GROSS TOTAL	GROS.PART.T.
388	PARTIAL GROSS TOTAL	GROSS.PART.T.XXXXXXXXX b UMD+T
395	JUST PARTIAL GROSS TOTAL	XXXXXXXXXX
396	JUST TEXT PARTIAL GROSS TOTAL	TARE b PART.T.
397	PARTIAL GROSS TOTAL	TARE b PART.T.XXXXXXXXX b UMD+T
404	JUST PARTIAL WEIGHS TOTAL	XXXXXXXXXX
405	JUST TEXT PARTIAL WEIGHS TOTAL	WGTS b PART.T.
406	PARTIAL WEIGHS TOTAL	WGTS b PART.T.XXXXXXXXX+T
GENERAL TOTAL		
380	JUST GENERAL NET TOTAL	XXXXXXXXXX
381	JUST TEXT GENERAL NET TOTAL	NET bb GEN.TOT
382	GENERAL NET TOTAL	NET bb GEN.TOTXXXXXXXX b UMD+T
389	JUST GENERAL GROSS TOTAL	XXXXXXXXXX
390	JUST TEXT GENERAL GROSS TOTAL	GROS b GEN.TOT
391	GENERAL GROSS TOTAL	GROS b GEN.TOTXXXXXXXX b UMD+T
398	JUST GENERAL TARE TOTAL	XXXXXXXXXX
399	JUST TEXT GENERAL TARE TOTAL	TARE b GEN.TOT
400	GENERAL TARE TOTAL	TARE b GEN.TOTXXXXXXXX b UMD+T
407	JUST GENERAL WEIGHS TOTAL	XXXXXXXXXX
408	JUST TEXT GENERAL WEIGHS TOTAL	WGTS b GEN.TOT
409	GENERAL WEIGHS TOTAL	WGTS b GEN.TOTXXXXXXXX+T
GRAND TOTAL		
383	JUST GRAND NET TOTAL NET	XXXXXXXXXX
384	JUST TEXT GRAND NET TOTAL	NET bb GRAND T
385	GRAND NET TOTAL	NET bb GRAND TXXXXXXXX b UMD+T
392	JUST GRAND GROSS TOTAL	XXXXXXXXXX

393	JUST TEXT GRAND GROSS TOTAL	GROS.GRAND T
394	GRAND GROSS TOTAL	GROS.GRAND TXXXXXXXX UMD +T
401	JUST GRAND TARE TOTAL	XXXXXXXX
402	JUST TEXT GRAND TARE TOTAL	TARE GRAND T
403	GRAND TARE TOTAL	TARE GRAND TXXXXXXXX UMD +T
410	JUST GRAND WEIGHS TOTAL	XXXXXXXX
412	GRAND WEIGHS TOTAL	WGTS GRAND TXXXXXXXX+T
411	JUST TEXT GRAND WEIGHS TOTAL	WGTS GRAND T

LOT TOTAL

422	JUST TEXT LOT NET TOTAL	T.LOT.NET bb
423	JUST LOT NET TOTAL	XXXXXXXX
424	LOT NET TOTAL	T.LOT.NET bb XXXXXXXX UMD +T
425	JUST TEXT LOT GROSS TOTAL	T.LOT.GROSS
426	JUST LOT GROSS TOTAL	XXXXXXXX
427	LOT GROSS TOTAL	T.LOT.GROSSXXXXXXXX UMD +T
428	JUST TEXT LOT TARE TOTAL	T.LOT.TARE bb
429	JUST LOT TARE TOTAL	XXXXXXXX
430	LOT TARE TOTAL	T.LOT.TARE bb XXXXXXXX UMD +T
431	JUST TEXT LOT WEIGHS TOTAL	T.LOT.WGTS bb
432	JUST LOT WEIGHS TOTAL	XXXXXXXX
433	LOT WEIGHS TOTAL	T.LOT.WGTS bb XXXXXXXX+T
465	ONLY LOT TOT. WEIGH NUMBER	XXXXXX

JUST TEXTS

304	JUST TEXT "NET ="	NET bb =
305	JUST TEXT "GROSS ="	GROSS bb =
306	JUST TEXT "TARE ="	TARE bb =
501	JUST CONDITIONED TARE TEXT	XXXX
	XXXX becomes TARE in case of semiautomatic tare or PT bb in case of manual tare.	
502	JUST CONDITIONED PT TEXT	XX
	XX becomes bb in case of semiautomatic tare or PT in case of manual tare.	

PROGRESSIVES

374	TICKET PROGRESSIVE	XXXXX
	(number of partial total resettings)	
	the field expands from right tot left, with many spaces for completing the field length.	
375	LOT PROGRESSIVE	XXXXXX
	(number of general total resettings)	
	the field expands from right tot left, with many spaces for completing the field length	
	NOTE: It's not possible to manually clear this progressive number; it's automatically cleared when the 999999 value is reached.	

ADDITIONAL VALUE

413	JUST PARTIAL ADDITIONAL TOTAL	XXXXXXXX
414	JUST TEXT PARTIAL ADDITIONAL TOTAL	ADD. bb PART.T.
415	PARTIAL ADDITIONAL TOTAL	ADD. bb PART.T. XXXXXXXX+T
416	JUST GENERAL ADDITIONAL TOTAL	XXXXXXXX
417	JUST TEXT GENERAL ADDITIONAL TOTAL	ADD. bb GEN.TOT
418	GENERAL ADDITIONAL TOTAL	ADD. bb GEN.TOTXXXXXXXX+T
419	JUST GRAND ADDITIONAL TOTAL	XXXXXXXX

420 JUST TEXT GRAND ADDITIONAL TOTAL ADD.bGRAND T
 421 GRAND ADDITIONAL TOTAL ADD.bGRAND TXXXXXXXXX+T

ARTICLE

376 ACTIVE ARTICLE MEMORY TOTAL XXX
 the field is expressed with three digits, with the zeros to complete the field length.
 The block is always printed, also without any article selected (= - 001).

447 1st ARTICLE DESCRIPTION DES.1**b**ART.XXXXXXXXXXXXXXXXXXXXXX+T
 448 JUST TEXT 1st ARTICLE DESCRIPTION DES.1**b**ART.
 449 JUST VALUE 1st ARTICLE DESCRIPTION XXXXXXXXXXXXXXXXXXXXXXXX+T
 450 2nd ARTICLE DESCRIPTION DES.2**b**ART.XXXXXXXXXXXXXXXXXXXXXX+T
 451 JUST TEXT 2nd ARTICLE DESCRIPTION DES.2**b**ART.
 452 JUST VALUE 2nd ARTICLE DESCRIPTION XXXXXXXXXXXXXXXXXXXXXXXX+T
 455 3rd ARTICLE DESCRIPTION DES.3**b**ART.XXXXXXXXXXXXXXXXXXXXXX+T
 456 ONLY TEXT OF 3rd ARTICLE DESCRIPTION DES.3**b**ART.
 457 ONLY VALUE OF 3rd ARTICLE DESCRIPTION XXXXXXXXXXXXXXXXXXXXXXXX
 522 ARTICLE DENSITY DENSITY**b**XXXXXXXX+T
 521 ONLY VALUE OF ARTICLE DENSITY XXXXXXXX
 520 ONLY DENSITY TEXT DENSITY
 523 ONLY VALUE OF ARTICLE TARGET XXXXXXXX
 524 ARTICLE TARGET TARGET:**b**XXXXXXXXXUMD + T
 The block refers to the check with article and tolerances (see << CHECK.t >> step).

503 JUST TEXT ARTICLE NET TOTAL T.ART.NET**bb**
 504 JUST ARTICLE NET TOTAL XXXXXXXX
 505 ARTICLE NET TOTAL T.ART.NET**bb**XXXXXXXXXUMD+T

506 JUST TEXT ARTICLE GROSS TOTAL T.ART.GROSS
 507 JUST ARTICLE GROSS TOTAL XXXXXXXX
 508 ARTICLE GROSS TOTAL T.ART.GROSSXXXXXXXXXUMD+T

509 JUST TEXT ARTICLE TARE TOTAL T.ART.TARE**b**
 510 JUST ARTICLE TARE TOTAL XXXXXXXX
 511 ARTICLE TARE TOTAL T.ART.TARE**b**XXXXXXXXXUMD+T

512 JUST TEXT ARTICLE WEIGHS TOTAL T.ART.WGTS**b**
 513 JUST ARTICLE WEIGHS TOTAL XXXXXXXX
 514 ARTICLE WEIGHS TOTAL T.ART.WGTS**b**XXXXXXXXXT

515 JUST TEXT ARTICLE INDEX IND.ART**bbb**
 516 JUST VALUE ARTICLE INDEX XXX
 517 ARTICLE INDEX IND.ART**bbb** XXX + T
 The blocks nr. 515, 516, 517 are printed only if an article has been set.

INPUT TEXTS

315 JUST INPUT 1 TEXT HEADING XXXXXXXXXXXXXXXXXXXX
 in which XXXXXXXXXXXXXXXXXXXX are 16 characters of the input 1 text heading; just the entered characters are
 printed, from left to right.

316 JUST INPUT 2 TEXT HEADING XXXXXXXXXXXXXXXXXXXX
 317 JUST INPUT 3 TEXT HEADING XXXXXXXXXXXXXXXXXXXX
 318 JUST INPUT 4 TEXT HEADING XXXXXXXXXXXXXXXXXXXX
 319 JUST INPUT 5 TEXT HEADING XXXXXXXXXXXXXXXXXXXX
 320 JUST INPUT 6 TEXT HEADING XXXXXXXXXXXXXXXXXXXX
 321 JUST INPUT 7 TEXT HEADING XXXXXXXXXXXXXXXXXXXX
 322 JUST INPUT 8TEXT HEADING XXXXXXXXXXXXXXXXXXXX
 323 JUST INPUT 9 TEXT HEADING XXXXXXXXXXXXXXXXXXXX

324 JUST INPUT 10 TEXT HEADING XXXXXXXXXXXXXXXXXXXX
 325 JUST INPUT 11 TEXT HEADING XXXXXXXXXXXXXXXXXXXX
 326 JUST INPUT 12 TEXT HEADING XXXXXXXXXXXXXXXXXXXX
 327 JUST INPUT 13 TEXT HEADING XXXXXXXXXXXXXXXXXXXX
 328 JUST INPUT 14 TEXT HEADING XXXXXXXXXXXXXXXXXXXX
 329 JUST INPUT 15 TEXT HEADING XXXXXXXXXXXXXXXXXXXX
 330 JUST THE INPUT 1 TEXT CONTENTS YYYYYYYYYYYYYYYYYY

in which YYYYYYYYYYYYYYYY are 16 characters of the input 1 text contents; just the entered characters are printed, from left to right.

331 JUST THE INPUT 2 TEXT CONTENTS YYYYYYYYYYYYYYYYYY
 332 JUST THE INPUT 3 TEXT CONTENTS YYYYYYYYYYYYYYYYYY
 333 JUST THE INPUT 4 TEXT CONTENTS YYYYYYYYYYYYYYYYYY
 334 JUST THE INPUT 5 TEXT CONTENTS YYYYYYYYYYYYYYYYYY
 335 JUST THE INPUT 6 TEXT CONTENTS YYYYYYYYYYYYYYYYYY
 336 JUST THE INPUT 7 TEXT CONTENTS YYYYYYYYYYYYYYYYYY
 337 JUST THE INPUT 8 TEXT CONTENTS YYYYYYYYYYYYYYYYYY
 338 JUST THE INPUT 9 TEXT CONTENTS YYYYYYYYYYYYYYYYYY
 339 JUST THE INPUT 10 TEXT CONTENTS YYYYYYYYYYYYYYYYYY
 340 JUST THE INPUT 11 TEXT CONTENTS YYYYYYYYYYYYYYYYYY
 341 JUST THE INPUT 12 TEXT CONTENTS YYYYYYYYYYYYYYYYYY
 342 JUST THE INPUT 13 TEXT CONTENTS YYYYYYYYYYYYYYYYYY
 343 JUST THE INPUT 14 TEXT CONTENTS YYYYYYYYYYYYYYYYYY
 344 JUST THE INPUT 15 TEXT CONTENTS YYYYYYYYYYYYYYYYYY

345 INPUT 1 TEXT XXXXXXXXXXXXXXXXXXXXbYYYYYYYYYYYYYYYYY + T

in which XXXXXXXXXXXXXXXXXXXX are 16 characters of the heading and YYYYYYYYYYYYYYYYYY are 16 characters of the input 1 text contents, just the entered characters are printed, from left to right.

346 INPUT 2 TEXT XXXXXXXXXXXXXXXXXXXXbYYYYYYYYYYYYYYYYY + T
 347 INPUT 3 TEXT XXXXXXXXXXXXXXXXXXXXbYYYYYYYYYYYYYYYYY + T
 348 INPUT 4 TEXT XXXXXXXXXXXXXXXXXXXXbYYYYYYYYYYYYYYYYY + T
 349 INPUT 5 TEXT XXXXXXXXXXXXXXXXXXXXbYYYYYYYYYYYYYYYYY + T
 350 INPUT 6 TEXT XXXXXXXXXXXXXXXXXXXXbYYYYYYYYYYYYYYYYY + T
 351 INPUT 7 TEXT XXXXXXXXXXXXXXXXXXXXbYYYYYYYYYYYYYYYYY + T
 352 INPUT 8 TEXT XXXXXXXXXXXXXXXXXXXXbYYYYYYYYYYYYYYYYY + T
 353 INPUT 9 TEXT XXXXXXXXXXXXXXXXXXXXbYYYYYYYYYYYYYYYYY + T
 354 INPUT 10 TEXT XXXXXXXXXXXXXXXXXXXXbYYYYYYYYYYYYYYYYY + T
 355 INPUT 11 TEXT XXXXXXXXXXXXXXXXXXXXbYYYYYYYYYYYYYYYYY + T
 356 INPUT 12 TEXT XXXXXXXXXXXXXXXXXXXXbYYYYYYYYYYYYYYYYY + T
 357 INPUT 13 TEXT XXXXXXXXXXXXXXXXXXXXbYYYYYYYYYYYYYYYYY + T
 358 INPUT 14 TEXT XXXXXXXXXXXXXXXXXXXXbYYYYYYYYYYYYYYYYY + T
 359 INPUT 15 TEXT XXXXXXXXXXXXXXXXXXXXbYYYYYYYYYYYYYYYYY + T

ALIBI MEMORY

519* LAST NET WEIGHT ON ALIBI MEMORY XXXXXXXXXXXX
 in which XXXXXXXXXXXX indicates the weight value on 10 digits including the comma
 434* LAST GROSS WEIGHT ON ALIBI MEMORY XXXXXXXXXXXX
 in which XXXXXXXXXXXX indicates the weight ID on 10 digits, including the comma.
 435* LAST TARE ON ALIBI MEMORY XXXXXXXXXXXX
 436* ACTIVE SCALE NUMBER WITH ALIBI MEMORY XX
 437* ID PRINTING XXXXXX
 in which XXXXXX indicates the weight ID on 6 digits, including the comma; the field expands from right to left.
 438* WEIGH UNIT OF MEASURE WITH ALIBI MEMORY UM
 518 JUST NUMBER OF ALIBI MEMORY REWRITINGS XXXXX

STATISTICAL CHECK		
-------------------	--	--

441	JUST DATE TIME TEXT AT ACQUISITION START	BEGIN b TIME b DATE
442	JUST DATE TIME VALUE AT ACQUISITION START	b GG/MM/A b HH:MM:SS
443	DATE TIME ACQUISITION START	BEGIN b TIME b DATE
		b GG/MM/A b HH:MM:SS
444	JUST DATE TIME TEXT AT ACQUISITION END	END b TIME b DATE
445	JUST DATE TIME VALUE AT ACQUISITION END	b GG/MM/A b HH:MM:SS
446	DATE TIME ACQUISITION END	END b TIME b DATE
		b GG/MM/A b HH:MM:SS
453	JUST TARGET TEXT	TARGET: b
454	JUST TARGET VALUE	XXXXXXXX
455	TARGET	TARGET: b XXXXXXXXXUMD + T
456	JUST T1 TEXT	T1: b
457	JUST T1 VALUE	XXXXXXXX
458	JUST T2 TEXT	T2: b
459	JUST T2 VALUE	XXXXXXXX
460	JUST T3 TEXT	T3: b
461	JUST T3 VALUE	XXXXXXXX
	The blocks from 453 to 461 refer to the check with article and tolerances (see << CHECK.t >> step).	
462	JUST 1° TEXT WEIGH HEADER	WEIGH b bb b bb
463	JUST 2° TEXT WEIGH HEADER	NET b b
464	WEIGH HEADER	WEIGH b bb b bbNET b b
465	JUST WEIGH NUMBER	XXXXXX
466	JUST TOTALIZED WEIGHT	b XXXXXXXX
467	CURRENT WEIGH	XXXXXX b XXXXXXXXXUMD + T
468	JUST TEXT AVERAGE WEIGHT	WGT. b AV G b
469	JUST VALUE AVERAGE WEIGHT	XXXXXXXX
470	AVERAGE WEIGHT	WGT. b AV G bXXXXXXXXXUMD + T
471	JUST TEXT STANDARD DEVIATION	STD.DEV. b bb
472	JUST VALUE INTEGRAL STANDARD DEVIATION	XXXXXXXX
473	STANDARD DEVIATION	STD.DEV. b bbXXXXXXXXXUMD+T
	In which the standard deviation is calculated using the integral number of samples.	
NOTE:	the number of decimals with which the standard deviation is printed is the number of decimals set in the database + 1.	
474	JUST TEXT WEIGH UNDER T1	WGT.UNDER b T1
475	JUST VALUE WEIGH UNDER T1	XXXXXXXX
476	WEIGH UNDER T1	WGT.UNDER b T1XXXXXXXX + T
477	JUST TEXT WEIGH UNDER T2	WGT.UNDER b T2
478	JUST VALUE WEIGH UNDER T2	XXXXXXXX
479	WEIGH UNDER T2	WGT.UNDER b T2XXXXXXXX + T
480	JUST TEXT WEIGH UNDER T3	WGT.UNDER b T3
481	JUST VALUE WEIGH UNDER T3	XXXXXXXX
482	WEIGH UNDER T3	WGT.UNDER b T3XXXXXXXX + T
483	JUST TEXT WEIGH OVER T1	WEIG.OVER b T1
484	JUST VALUE WEIGH OVER T1	XXXXXXXX
485	WEIGH OVER T1	WEIG.OVER b T1XXXXXXXX + T
486	JUST TEXT WEIGH OVER T2	WEIG.OVER b T2
487	JUST VALUE WEIGH OVER T2	XXXXXXXX
488	WEIGH OVER T2	WEIG.OVER b T2XXXXXXXX + T
489	JUST TEXT WEIGH OVER T3	WEIG.OVER b T3
490	JUST VALUE WEIGH OVER T3	XXXXXXXX
491	WEIGH OVER T3	WEIG.OVER b T3XXXXXXXX + T
	The blocks from 474 to 491 refer to the check with article and tolerances (see << CHECK.t >> step).	
	The number of weighs concerns the totalised weighs .	
492	JUST TEXT WEIGHS OK	WEIGHS b OK b bb
493	JUST VALUE WEIGHS OK	XXXXXXXX

494	WEIGHS OK	WEIGHS bOKbbb XXXXXXXX + T
495	JUST TEXT MINIMUM WEIGHT	WGT. bMINbbb
496	JUST VALUE MINIMUM WEIGHT	XXXXXXXX
497	MINIMUM WEIGHT	WGT. bMINbbb XXXXXXXXXUMD+T
498	JUST TEXT MAXIMUM WEIGHT	WGT. bMAXbbb
499	JUST VALUE MAXIMUM WEIGHT	XXXXXXXX
500	MAXIMUM WEIGHT	WGT. bMAXbbb XXXXXXXXXUMD + T

The blocks from 495 to 500 refer to the check with article and tolerances (see << **CHECK.t** >> step).

533	JUST TEXT MINIMUM WEIGHT	T.min: bbb
534	JUST VALUE MINIMUM WEIGHT	XXXXXXXX
535	JUST TEXT MAXIMUM WEIGHT	T.MAX: bbb
536	JUST VALUE MAXIMUM WEIGHT	XXXXXXXX
537	JUST TEXT WEIGHS UNDER MINIMUM WEIGHT	WEI.UNDER bTm
538	JUST VALUE WEIGHS UNDER MINIMUM WEIGHT	XXXXXXXX
539	WEIGHS UNDER MINIMUM WEIGHT	WEI.UNDER bTm XXXXXXXX + T
540	JUST TEXT WEIGHS UNDER MAXIMUM WEIGHT	WEI.OVER bTM
541	JUST VALUE WEIGHS UNDER MAXIMUM WEIGHT	XXXXXXXX
542	WEIGHS OVER MAXIMUM WEIGHT	WEI.OVER bTM XXXXXXXX + T

The blocks from 533 to 542 refer to the check with setting of minimum and maximum thresholds (see << **CHECK.t** >> step); the number of weighs concerns **the totalised weighs**.

543 JUST TEXT SYSTEM STATUS
NOTE: Refer to all the system status, see the section 5.3.1 (**USER MAN.REF.**).

10.3.2 NUMERICAL ORDER

CODE

PRINT FORMAT

300	PRINT END	
301	JUST NET WEIGHT	XXXXXXXXXX
302	JUST GROSS WEIGHT	XXXXXXXXXX
303	JUST TARE WEIGHT	XXXXXXXXXX
304	JUST TEXT "NET ="	NET bbb =
305	JUST TEXT "GROSS ="	GROSS b =
306	JUST TEXT "TARE ="	TARE bb =
307	NET WEIGHT	NET bbb =bXXXXXXXXXXUM + T
	in which XXXXXXXXXXXX is the weight value on 10 digits including the comma.	
308	GROSS WEIGHT	GROSS=bXXXXXXXXXXUM + T
309	TARE WEIGHT	TARE b =bXXXXXXXXXXUM + T
310	DOTTED LINE	----- + T
311	DATE / TIME FOR DP24/DP190	bHH:MMbDD-MM-YY + T
	the date and time of the printer is printed; one can adjust it through the printer.	
312	PRINTS ON PC PORT	
313	PRINTS ON PRINTER PORT	
314	FORCES PRINTOUT	
315	JUST INPUT 1 TEXT HEADING	XXXXXXXXXXXXXXXXXX
	in which XXXXXXXXXXXXXXXXXXXX are 16 characters of the input 1 text heading; just the entered characters are printed, from left to right.	
316	JUST INPUT 2 TEXT HEADING	XXXXXXXXXXXXXXXXXX
317	JUST INPUT 3 TEXT HEADING	XXXXXXXXXXXXXXXXXX
318	JUST INPUT 4 TEXT HEADING	XXXXXXXXXXXXXXXXXX
319	JUST INPUT 5 TEXT HEADING	XXXXXXXXXXXXXXXXXX
320	JUST INPUT 6 TEXT HEADING	XXXXXXXXXXXXXXXXXX
321	JUST INPUT 7 TEXT HEADING	XXXXXXXXXXXXXXXXXX
322	JUST INPUT 8TEXT HEADING	XXXXXXXXXXXXXXXXXX
323	JUST INPUT 9 TEXT HEADING	XXXXXXXXXXXXXXXXXX

324 JUST INPUT 10 TEXT HEADING XXXXXXXXXXXXXXXXXXXX
 325 JUST INPUT 11 TEXT HEADING XXXXXXXXXXXXXXXXXXXX
 326 JUST INPUT 12 TEXT HEADING XXXXXXXXXXXXXXXXXXXX
 327 JUST INPUT 13 TEXT HEADING XXXXXXXXXXXXXXXXXXXX
 328 JUST INPUT 14 TEXT HEADING XXXXXXXXXXXXXXXXXXXX
 329 JUST INPUT 15 TEXT HEADING XXXXXXXXXXXXXXXXXXXX
 330 JUST THE INPUT 1 TEXT CONTENTS YYYYYYYYYYYYYYYYYY

in which YYYYYYYYYYYYYYYY are 16 characters of the input 1 text contents; just the entered characters are printed, from left to right.

331 JUST THE INPUT 2 TEXT CONTENTS YYYYYYYYYYYYYYYYYY
 332 JUST THE INPUT 3 TEXT CONTENTS YYYYYYYYYYYYYYYYYY
 333 JUST THE INPUT 4 TEXT CONTENTS YYYYYYYYYYYYYYYYYY
 334 JUST THE INPUT 5 TEXT CONTENTS YYYYYYYYYYYYYYYYYY
 335 JUST THE INPUT 6 TEXT CONTENTS YYYYYYYYYYYYYYYYYY
 336 JUST THE INPUT 7 TEXT CONTENTS YYYYYYYYYYYYYYYYYY
 337 JUST THE INPUT 8 TEXT CONTENTS YYYYYYYYYYYYYYYYYY
 338 JUST THE INPUT 9 TEXT CONTENTS YYYYYYYYYYYYYYYYYY
 339 JUST THE INPUT 10 TEXT CONTENTS YYYYYYYYYYYYYYYYYY
 340 JUST THE INPUT 11 TEXT CONTENTS YYYYYYYYYYYYYYYYYY
 341 JUST THE INPUT 12 TEXT CONTENTS YYYYYYYYYYYYYYYYYY
 342 JUST THE INPUT 13 TEXT CONTENTS YYYYYYYYYYYYYYYYYY
 343 JUST THE INPUT 14 TEXT CONTENTS YYYYYYYYYYYYYYYYYY
 344 JUST THE INPUT 15 TEXT CONTENTS YYYYYYYYYYYYYYYYYY

345 INPUT 1 TEXT XXXXXXXXXXXXXXXXXXXXbYYYYYYYYYYYYYYYYY + T

in which XXXXXXXXXXXXXXXXXXXX are 16 characters of the heading and YYYYYYYYYYYYYYYYYY are 16 characters of the input 1 text contents, just the entered characters are printed, from left to right.

346 INPUT 2 TEXT XXXXXXXXXXXXXXXXXXXXbYYYYYYYYYYYYYYYYY + T
 347 INPUT 3 TEXT XXXXXXXXXXXXXXXXXXXXbYYYYYYYYYYYYYYYYY + T
 348 INPUT 4 TEXT XXXXXXXXXXXXXXXXXXXXbYYYYYYYYYYYYYYYYY + T
 349 INPUT 5 TEXT XXXXXXXXXXXXXXXXXXXXbYYYYYYYYYYYYYYYYY + T
 350 INPUT 6 TEXT XXXXXXXXXXXXXXXXXXXXbYYYYYYYYYYYYYYYYY + T
 351 INPUT 7 TEXT XXXXXXXXXXXXXXXXXXXXbYYYYYYYYYYYYYYYYY + T
 352 INPUT 8 TEXT XXXXXXXXXXXXXXXXXXXXbYYYYYYYYYYYYYYYYY + T
 353 INPUT 9 TEXT XXXXXXXXXXXXXXXXXXXXbYYYYYYYYYYYYYYYYY + T
 354 INPUT 10 TEXT XXXXXXXXXXXXXXXXXXXXbYYYYYYYYYYYYYYYYY + T
 355 INPUT 11 TEXT XXXXXXXXXXXXXXXXXXXXbYYYYYYYYYYYYYYYYY + T
 356 INPUT 12 TEXT XXXXXXXXXXXXXXXXXXXXbYYYYYYYYYYYYYYYYY + T
 357 INPUT 13 TEXT XXXXXXXXXXXXXXXXXXXXbYYYYYYYYYYYYYYYYY + T
 358 INPUT 14 TEXT XXXXXXXXXXXXXXXXXXXXbYYYYYYYYYYYYYYYYY + T
 359 INPUT 15 TEXT XXXXXXXXXXXXXXXXXXXXbYYYYYYYYYYYYYYYYY + T

360 DATE INDICATOR DD-MM-YY + T
 361 TIME INDICATOR HH:MM + T
 362 DATE TIME INDICATOR HH:MMbDD-MM-YY + T

363 FOLLOWING MACRO TERMINATOR SKIPS
 364 HEADING 1 XXXXXXXXXXXXXXXXXXXXXXXXXXXX + T
 365 HEADING 2 XXXXXXXXXXXXXXXXXXXXXXXXXXXX + T
 366 HEADING 3 XXXXXXXXXXXXXXXXXXXXXXXXXXXX + T

in which XXXXXXXXXXXXXXXXXXXX are the 24 characters of the first line of the heading; just the entered characters are printed, from left to right.

367 JUST GROSS ON 10 DIGITS XXXXXXXXXX
 368 JUST NET ON 10 DIGITS XXXXXXXXXX
 369 JUST TARE ON 10 DIGITS XXXXXXXXXX

the field expands from right to left with many spaces for completing the field length.

370 ACTIVE SCALE NUMBER SCALEbNUMBERbX + T

in which X is the active scale number (1..4)

371 JUST ACTIVE SCALE NUMBER X

372	SCALE UNIT OF MEASURE	UM + T
373	DATABASE UNIT OF MEASURE	UM + T
374	TICKET PROGRESSIVE (number of partial total resettings) the field expands from right tot left, with many spaces for completing the field length.	XXXXX
375	LOT PROGRESSIVE (number of general total resettings) the field expands from right tot left, with many spaces for completing the field length NOTE: It's not possible to manually clear this progressive number; it's automatically cleared when the 999999 value is reached.	XXXXXX
376	ACTIVE ARTICLE MEMORY TOTAL the field is expressed with three digits, with the zeros to complete the field length. The block is printed always, also without any article selected (= - 001).	XXX
377	JUST PARTIAL NET TOTAL	XXXXXXXXX
378	JUST TEXT PARTIAL NET TOTAL	NET bb PART.T.
379	PARTIAL NET TOTAL	NET bb PART.T.XXXXXXXXX b UMD+T
380	JUST GENERAL NET TOTAL	XXXXXXXXX
381	JUST TEXT GENERAL NET TOTAL	NET bb GEN.TOT
382	GENERAL NET TOTAL	NET bb GEN.TOTXXXXXXXX b UMD+T
383	JUST GRAND NET TOTAL NET	XXXXXXXXX
384	JUST TEXT GRAND NET TOTAL	NET bb GRAND T
385	GRAND NET TOTAL	NET bb GRAND TXXXXXXXX b UMD+T
386	JUST PARTIAL GROSS TOTAL	XXXXXXXXX
387	JUST TEXT PARTIAL GROSS TOTAL	GROS.PART.T.
388	PARTIAL GROSS TOTAL	GROS.PART.T.XXXXXXXXX b UMD+T
389	JUST GENERAL GROSS TOTAL	XXXXXXXXX
390	JUST TEXT GENERAL GROSS TOTAL	GROS b GEN.TOT
391	GENERAL GROSS TOTAL	GROS b GEN.TOTXXXXXXXX b UMD+T
392	JUST GRAND GROSS TOTAL	XXXXXXXXX
393	JUST TEXT GRAND GROSS TOTAL	GROS.GRAND T
394	GRAND GROSS TOTAL	GROS.GRAND TXXXXXXXX b UMD+T
395	JUST PARTIAL GROSS TOTAL	XXXXXXXXX
396	JUST TEXT PARTIAL GROSS TOTAL	TARE b PART.T.
397	PARTIAL GROSS TOTAL	TARE b PART.T.XXXXXXXXX b UMD+T
398	JUST GENERAL TARE TOTAL	XXXXXXXXX
399	JUST TEXT GENERAL TARE TOTAL	TARE b GEN.TOT
400	GENERAL TARE TOTAL	TARE b GEN.TOTXXXXXXXX b UMD+T
401	JUST GRAND TARE TOTAL	XXXXXXXXX
402	JUST TEXT GRAND TARE TOTAL	TARE b GRAND T
403	GRAND TARE TOTAL	TARE b GRAND TXXXXXXXX b UMD+T
404	JUST PARTIAL WEIGHS TOTAL	XXXXXXXXX
405	JUST TEXT PARTIAL WEIGHS TOTAL	WGTS b PART.T.
406	PARTIAL WEIGHS TOTAL	WGTS b PART.T.XXXXXXXXX+T
407	JUST GENERAL WEIGHS TOTAL	XXXXXXXXX
408	JUST TEXT GENERAL WEIGHS TOTAL	WGTS b GEN.TOT
409	GENERAL WEIGHS TOTAL	WGTS b GEN.TOTXXXXXXXX+T
410	JUST GRAND WEIGHS TOTAL	XXXXXXXXX
411	JUST TEXT GRAND WEIGHS TOTAL	WGTS b GRAND T
412	GRAND WEIGHS TOTAL	WGTS b GRAND TXXXXXXXX+T
413	JUST PARTIAL ADDITIONAL TOTAL	XXXXXXXXX
414	JUST TEXT PARTIAL ADDITIONAL TOTAL	ADD. b PART.T.
415	PARTIAL ADDITIONAL TOTAL	ADD. b PART.T.XXXXXXXXX+T
416	JUST GENERAL ADDITIONAL TOTAL	XXXXXXXXX
417	JUST TEXT GENERAL ADDITIONAL TOTAL	ADD. b GEN.TOT
418	GENERAL ADDITIONAL TOTAL	ADD. b GEN.TOTXXXXXXXX+T
419	JUST GRAND ADDITIONAL TOTAL	XXXXXXXXX

420	JUST TEXT GRAND ADDITIONAL TOTAL	ADD.bGRAND T
421	GRAND ADDITIONAL TOTAL	ADD.bGRAND TXXXXXXXXX+T
422	JUST TEXT LOT NET TOTAL	T.LOT.NET bb
423	JUST LOT NET TOTAL	XXXXXXXXXX
424	LOT NET TOTAL	T.LOT.NET bb XXXXXXXXXXUMD+T
425	JUST TEXT LOT GROSS TOTAL	T.LOT.GROSS
426	JUST LOT GROSS TOTAL	XXXXXXXXXX
427	LOT GROSS TOTAL	T.LOT.GROSSXXXXXXXXXXUMD+T
428	JUST TEXT LOT TARE TOTAL	T.LOT.TARE b
429	JUST LOT TARE TOTAL	XXXXXXXXXX
430	LOT TARE TOTAL	T.LOT.TARE b XXXXXXXXXXUMD+T
431	JUST TEXT LOT WEIGHS TOTAL	T.LOT.WGTS b
432	JUST LOT WEIGHS TOTAL	XXXXXXXXXX
433	LOT WEIGHS TOTAL	T.LOT.WGTS b XXXXXXXXXX+T
434*	LAST GROSS WEIGHT ON ALIBI MEMORY in which XXXXXXXXXXXX indicates the weight ID on 10 digits, including the comma.	XXXXXXXXXXXX
435*	LAST TARE ON ALIBI MEMORY	XXXXXXXXXXXX
436*	ACTIVE SCALE NUMBER WITH ALIBI MEMORY	XX
437*	ID PRINTING in which XXXXXX indicates the weight ID on 6 digits, including the comma; the field expands from right to left.	XXXXXXX
438*	WEIGH UNIT OF MEASURE WITH ALIBI MEMORY	UM
439	STANDARD KD PROTOCOL STRING	
440	AF0X PROTOCOL STRING By using blocks 439 and 440 it is possible to print the STANDARD or AFXX serial string (see section "TRANSMISSION PTOROCOLS" for the description); the string terminator is the one set in the tErMin "SET TERMINATOR TYPE" step in the SET-UP environment (CR or CRLF or no terminator).	
441	JUST DATE TIME TEXT AT ACQUISITION START	BEGIN b TIME b DATE
442	JUST DATE TIME VALUE AT ACQUISITION START	b GG/MM/A b HH:MM:SS
443	DATE TIME ACQUISITION START	BEGIN b TIME b DATE b GG/MM/A b HH:MM:SS
444	JUST DATE TIME TEXT AT ACQUISITION END	END b TIME b DATE
445	JUST DATE TIME VALUE AT ACQUISITION END	b GG/MM/A b HH:MM:SS
446	DATE TIME ACQUISITION END	END b TIME b DATE b GG/MM/A b HH:MM:SS
447	1 st ARTICLE DESCRIPTION	DES.1 b ART. XXXXXXXXXXXXXXXXXXXXXXXX+T
448	JUST TEXT 1 st ARTICLE DESCRIPTION	DES.1 b ART.
449	JUST VALUE 1 st ARTICLE DESCRIPTION	XXXXXXXXXXXXXXXXXXXXXXXXXX+T
450	2 nd ARTICLE DESCRIPTION	DES.2 b ART. XXXXXXXXXXXXXXXXXXXXXXXX+T
451	JUST TEXT 2 nd ARTICLE DESCRIPTION	DES.2 b ART.
452	JUST VALUE 2 nd ARTICLE DESCRIPTION	XXXXXXXXXXXXXXXXXXXXXXXXXX+T
453	JUST TARGET TEXT	TARGET: b
454	JUST TARGET VALUE	XXXXXXXXXX
455	TARGET	TARGET: b XXXXXXXXXXUMD + T
456	JUST T1 TEXT	T1: b
457	JUST T1 VALUE	XXXXXXXXXX
458	JUST T2 TEXT	T2: b
459	JUST T2 VALUE	XXXXXXXXXX
460	JUST T3 TEXT	T3: b
461	JUST T3 VALUE	XXXXXXXXXX
	The blocks from 453 to 461 refer to the check with article and tolerances (see << CHECK.t >> step).	
462	JUST 1 st TEXT WEIGH HEADER	WEIGH bbbbbb
463	JUST 2 nd TEXT WEIGH HEADER	NET bb
464	WEIGH HEADER	WEIGH bbbbbb NET bb
465	JUST WEIGH NUMBER	XXXXXX
466	JUST TOTALIZED WEIGHT	b XXXXXXXXXX
467	CURRENT WEIGH	XXXXXX b XXXXXXXXXXUMD + T

468	JUST TEXT AVERAGE WEIGHT	WGT.bAVGb
469	JUST VALUE AVERAGE WEIGHT	XXXXXXXXXX
470	AVERAGE WEIGHT	WGT.bAVGbXXXXXXXXXXUMD + T
471	JUST TEXT STANDARD DEVIATION	STD.DEV.bbb
472	JUST VALUE INTEGRAL STANDARD DEVIATION	XXXXXXXXXX
473	STANDARD DEVIATION	STD.DEV.bbbXXXXXXXXXXUMD+T

In which the standard deviation is calculated using the integral number of samples.

NOTE: the number of decimals with which the standard deviation is printed is the number of decimals set in the database + 1.

474	JUST TEXT WEIGH UNDER T1	WGT.UNDERbT1
475	JUST VALUE WEIGH UNDER T1	XXXXXXXXXX
476	WEIGH UNDER T1	WGT.UNDERbT1XXXXXXXXXX + T
477	JUST TEXT WEIGH UNDER T2	WGT.UNDERbT2
478	JUST VALUE WEIGH UNDER T2	XXXXXXXXXX
479	WEIGH UNDER T2	WGT.UNDERbT2XXXXXXXXXX + T
480	JUST TEXT WEIGH UNDER T3	WGT.UNDERbT3
481	JUST VALUE WEIGH UNDER T3	XXXXXXXXXX
482	WEIGH UNDER T3	WGT.UNDERbT3XXXXXXXXXX + T
483	JUST TEXT WEIGH OVER T1	WEIG.OVERbT1
484	JUST VALUE WEIGH OVER T1	XXXXXXXXXX
485	WEIGH OVER T1	WEIG.OVERbT1XXXXXXXXXX + T
486	JUST TEXT WEIGH OVER T2	WEIG.OVERbT2
487	JUST VALUE WEIGH OVER T2	XXXXXXXXXX
488	WEIGH OVER T2	WEIG.OVERbT2XXXXXXXXXX + T
489	JUST TEXT WEIGH OVER T3	WEIG.OVERbT3
490	JUST VALUE WEIGH OVER T3	XXXXXXXXXX
491	WEIGH OVER T3	WEIG.OVERbT3XXXXXXXXXX + T

The blocks from 474 to 491 refer to the check with article and tolerances (see << **CHECK.t** >> step).

The number of weighs concerns **the totalised weighs**.

492	JUST TEXT WEIGHS OK	WEIGHSbOKbbb
493	JUST VALUE WEIGHS OK	XXXXXXXXXX
494	WEIGHS OK	WEIGHSbOKbbbXXXXXXXXXX + T
495	JUST TEXT MINIMUM WEIGHT	WGT.bMINbbb
496	JUST VALUE MINIMUM WEIGHT	XXXXXXXXXX
497	MINIMUM WEIGHT	WGT.bMINbbbXXXXXXXXXXUMD+T
498	JUST TEXT MAXIMUM WEIGHT	WGT.bMAXbbb
499	JUST VALUE MAXIMUM WEIGHT	XXXXXXXXXX
500	MAXIMUM WEIGHT	WGT.bMAXbbbXXXXXXXXXXUMD + T

The blocks from 495 to 500 refer to the check with article and tolerances (see << **CHECK.t** >> step).

501	JUST CONDITIONED TARE TEXT	XXXX
-----	----------------------------	------

XXXX becomes TARE in case of semiautomatic tare or PT**bb** in case of manual tare.

502	JUST CONDITIONED PT TEXT	XX
-----	--------------------------	----

XX becomes **bb** in case of semiautomatic tare or PT in case of manual tare.

503	JUST TEXT ARTICLE NET TOTAL	T.ART.NETbb
504	JUST ARTICLE NET TOTAL	XXXXXXXXXX
505	ARTICLE NET TOTAL	T.ART.NETbbXXXXXXXXXXUMD+T
506	JUST TEXT ARTICLE GROSS TOTAL	T.ART.GROSS
507	JUST ARTICLE GROSS TOTAL	XXXXXXXXXX
508	ARTICLE GROSS TOTAL	T.ART.GROSSXXXXXXXXXXUMD+T
509	JUST TEXT ARTICLE TARE TOTAL	T.ART.TAREb
510	JUST ARTICLE TARE TOTAL	XXXXXXXXXX
511	ARTICLE TARE TOTAL	T.ART.TAREbXXXXXXXXXXUMD+T
512	JUST TEXT ARTICLE WEIGHS TOTAL	T.ART.WGTSb
513	JUST ARTICLE WEIGHS TOTAL	XXXXXXXXXX
514	ARTICLE WEIGHS TOTAL	T.ART.WGTSbXXXXXXXXXXT
515	JUST TEXT ARTICLE INDEX	IND.ARTbbb

516	JUST VALUE ARTICLE INDEX	XXX
517	ARTICLE INDEX	IND.ART bbb XXX + T
The blocks nr. 515, 516, 517 are printed only if an article has been set.		
518*	ONLY NUMBER OF ALIBI MEMORY REWRITINGS	XXXXX
519*	LAST NET WEIGHT ON ALIBI MEMORY	XXXXXXXXXX
in which XXXXXXXXXXXX indicates the weight value on 10 digits including the comma		
520	ONLY DENSITY TEXT	DENSITY
521	ONLY VALUE OF ARTICLE DENSITY	XXXXXX
522	ARTICLE DENSITY	DENSITY b XXXXXXXX+T
523	ONLY VALUE OF ARTICLE TARGET	XXXXXXXX
524	ARTICLE TARGET	TARGET: b XXXXXXXXXXUMD + T
525	3 RD ARTICLE DESCRIPTION	DES.3 b ART.XXXXXXXXXXXXXXXXXXXXXX+T
526	ONLY TEXT OF 3 RD ARTICLE DESCRIPTION	DES.3 b ART.
527	ONLY VALUE OF 3 RD ARTICLE DESCRIPTION	XXXXXXXXXXXXXXXXXXXXX
528	PRINT TERMINATOR	CR, CRLF, LF o NOT TERMINATOR
529	PRINT OF CALCULATED DATA	XXXXXXXXXX
530	PRINT OF ENTERED DATA	XXXXXXXX
531	PRINTS SECOND ENTERED DATUM	XXXXXXXX
532	PRINTS OPERATION SYMBOL	X
“+” in case of addition, “-” in case of subtraction, “x” in case of multiplication.		
The 529, 530, 531 and 532 blocks refer to the operation executed with the “calculator” function described in section “CALCULATOR”, USER MAN.REF.		

533	JUST TEXT MINIMUM WEIGHT	T.min: bbb
534	JUST VALUE MINIMUM WEIGHT	XXXXXXXX
535	JUST TEXT MAXIMUM WEIGHT	T.MAX: bbb
536	JUST VALUE MAXIMUM WEIGHT	XXXXXXXX
537	JUST TEXT WEIGHS UNDER MINIMUM WEIGHT	WEI.UNDER b Tm
538	JUST VALUE WEIGHS UNDER MINIMUM WEIGHT	XXXXXXXX
539	WEIGHS UNDER MINIMUM WEIGHT	WEI.UNDER b TmXXXXXXXX + T
540	JUST TEXT WEIGHS UNDER MAXIMUM WEIGHT	WEI.OVER b TM
541	JUST VALUE WEIGHS UNDER MAXIMUM WEIGHT	XXXXXXXX
542	WEIGHS OVER MAXIMUM WEIGHT	WEI.OVER b TMXXXXXXXX + T
The blocks from 533 to 542 refer to the check with setting of minimum and maximum thresholds (see << CHECK.t >> step); the number of weighs concerns the totalised weighs .		
543	JUST TEXT SYSTEM STATUS	
NOTE: Refer to all the system status, see the section 5.3.1 (USER MAN.REF.).		

10.4 BLOCKS WITH PARAMETERS

When entering the following blocks manually in a print ticket, these require that an additional numeric value be entered (specified in detail in the block's description) in order to define the print ticket which one wants to obtain.

EXAMPLE

Entry of the 600 “PRINT n TERMINATORS” block:

- Enter the 600 block in a ticket and confirm with OK/menu.
- The indicator does not pass by the block present in the following line, but shows “P 000”.
- Enter a value between 001 and 050; for values outside this interval the indicator shows “-Error-”, restoring the block before entering the block 600.
- By entering a valid value, the block will print a number of terminators equal to the one previously entered.

GENERIC

600	PRINTS n TERMINATORS	Values valid from 001 to 050
601	PRINTS n LF CHARACTERS	Values valid from 001 to 050
602	PRINTS n TAB CHARACTERS	Values valid from 001 to 050
603	PRINTS n SPACE CHARACTERS	Values valid from 001 to 050
604	PRINTS n “_” CHARACTERS	Values valid from 001 to 050

- 605 LEFT MARGIN FOR LX300 Values valid from 001 to 255
- 606 INSTANTANEOUS NET WEIGHT ON X DIGITS Values valid in the **nXX** format
- 607 INSTANTANEOUS GROSS WEIGHT ON X DIGITS Values valid in the **nXX** format
- 608 INSTANTANEOUS TARE WEIGHT ON X DIGITS Values valid in the **nXX** format

in which **n** can be:

- 0 Value with decimal point and spaces
- 1 Value with decimal point and zeros in the place of spaces
- 2 Value without decimal point and zeros in the place of spaces

XX is the field length (maximum enterable value is 20); if the weight value is greater than the number of entered digits, the complete value is printed anyways.

#####

EXAMPLE

With a weight value of 100.01, if one wants a length of 10 characters, in the three cases one will have:

Parameter	Result
010	100.01
110	0000100.01
210	0000010001

#####

- 609 SET VALUE IN THE ACCUMULATOR Values valid in the **XXX** format
- in which **XXX** can be:
- 000 Calculated net weight.
- 001 Calculated gross weight.
- 002 Calculated tare weight.
- 003 Net article total
- 004 Net partial total
- 005 Net general total
- 006 Net grand total
- 007 Article gross total
- 008 Partial gross total
- 009 General gross total
- 010 Gross grand total
- 011 Tare article total
- 012 Partial tare total
- 013 Tare general total
- 014 Tare grand total
- 015 Net lot total
- 016 Gross lot total
- 017 Tare lot total
- 018 Weighs' lot total

- 610 SETS VALUE DECIMALS IN THE ACCUMULATOR Values valid in the **XXX** format
- in which **XXX** can be:
- 000 No decimal
- 001 1 decimal
- 002 2 decimals
- 003 3 decimals
- 004 4 decimals

NOTE: if no decimals are set, the ones of the scale are used.

- 611 SETS CONVERSION UNIT OF MEASURE OF THE ACCUMULATOR VALUE
- Values valid in the **XXX** format in which **XXX** can be:
- 000 g

001 kg
 002 t
 003 lb

Then if the weight is expressed in grams and one uses the [601; 001] macro, the value will be converted into kg.

NOTE: if no unit of measure has been set, the one of the scale is used.

- 612 PRINTS VALUE LOADED IN THE ACCUMULATOR Values valid in the **nXX** format
 In which **n** can be:
 0 Value with decimal point and spaces
 1 Value with decimal point and zeros in the place of spaces
 2 Value without decimal point and zeros in the place of spaces

XX is the length of the field (maximum enterable value is 20); if the weight value is greater than the number of entered digits, the complete value is printed anyways.

#####

EXAMPLE

The scale is with three decimals and the unit of measure is the kg; one wants to print the net weight with two decimals converted in pounds, expressed in 7 digits without decimal points, with non significant zeros filling in the eventual spaces present.

One should set the following macros:

...
 609 >>> enter parameter 000
 610 >>> enter parameter 002
 611 >>> enter parameter 003
 612 >>> enter parameter 207

....
 If the net weight of the scale corresponds to 2,480 kg, the printed value will be **0000547**

#####

- 613 EAN/UCC CHECKDIGIT ON X PREVIOUS DIGITS Values valid in the **XX** format
 614 CONVERSION OF THE "." (POINT) CHARACTER IN THE "," (COMMA) CHARACTER
 IN THE PREVIOUS X DIGITS Values valid in the **XX** format

NOTE: if one uses the 613 and 614 blocks, one should enter the block 331 "FORCES PRINTING" before the blocks that need to be converted.

EXAMPLE

331 FORCES PRINTING
 301 PRINTS NET WEIGHT
 614 >>> parameter 20 CONVERSION OF THE "." (POINT) CHARACTER IN THE "," (COMMA)

The net weight value will be printed with the comma instead of with the point

- 616 SETTING THE THRESHOLD OF PRINT START OR THE NUMBER OF CHARACTERS TO BE PRINTED FOR
 THE INPUT TEXT CONTENTS Values valid in the **nXX** format
 This macro allows to define which part of the contents of an input text which is to be printed in the 618 macro.

n can be:

0 for setting the threshold beginning;
 1 for setting the characters to be printed.

XX is the threshold beginning if **n** = 0 or the characters to be printed if **n** = 1.

See the example in the 618 macro.

- 618 PRINTING OR CLEARING INPUT TEXT CONTENTS Values valid in the **nXX** format

This macro allows to print a part of an input text content defined in the 616 macro or to clear the contents of the input text content.

n can be:

0 to print;
1 to clear.

XX is the number of the input text (XX = 01 to print or clear the text contents of input 0, XX=15 to print or clear the contents of the text of input 14, XX=00 to clear all the contents of the input texts).

#####

EXAMPLE

If one wants to print from the 1st to the 6th letter of the contents of input text 0 and clear the contents.

One should set the following macros:

...

616 >>> enter parameter 000	Setting the start of the printing from the 1st character
619 >>> enter parameter 106	Setting the number of characters to be printed at 6.
618 >>> enter parameter 001	Printing the contents of the input 0 text with the set margins.
618 >>> enter parameter 101	Clearing the contents of the input 0 text.

....

#####

- 619 SETTING THE ALIGNMENT AND NUMBER OF FORMATTING CHARACTERS Values valid in the **nXX** format
This macro, followed by 620, allows to align to the right or to the left, the contents of the following macro in regards to the defined number of characters.

n can be:

0 to set the alignment to the right
1 to set the alignment to the left

XX is the number of formatting characters.

See the example in the 620 macro.

- 620 SETTING THE FILLING CHARACTER OF THE FOLLOWING MACRO Values valid in the **XXX** format.
This macro allows to set the filling character of the following macro.

XXX corresponds to the ASCII decimal character (from 001 to 255).

#####

EXAMPLE

If one wants to print on the right the contents of the 370 macro (NUMBER OF ACTIVE SCALE) one puts the “-“ character (ASCII decimal 045) as filling on the left.

The macro contains 17 characters; therefore if the print line is 24 one should set the following macros:

...

```
619 >>> enter parameter 024
620 >>> enter parameter 045
370 >>>
```

....

#####

- 621 CONFIRMATION “WAIT” FROM PC OR BY PRESSING OF **C** KEY Values valid in the **XXX** format

This macro allows to block the indicator and view the message “WAIT” on the display, after having forced the printing of the previous macros, and waiting for the character confirming that the reception has been made by the PC. In any case it’s possible to unlock the indicator by pressing the **C** key. Once unlocked, the indicator will print the eventual following macros.

XXX corresponds to the ASCII decimal character to be received in order to unlock the indicator (from 001 to 255, or 000 in case one wants to wait for the “PCOK” command).

NOTE: It’s possible to enter more than one confirmation “wait” in the same print format.

#####

EXAMPLE

One wants to lock the indicator after printing a series of data; then one waits for the “-“ confirmation character (ASCII decimal 045) and, once received, transmit other data.

One should set the following macros:

```

...
301
302
303
621 >>> enter parameter 045           Setting the wait of the “-“ character (ASCII decimal 045)
304
305
306
...
#####

```

624 **FORCES PRINTOUT AND TIME** Values valid in the **XXX** format
 Besides the force printout function, it waits also a period of time.
XXX Wait time (max 200dsec); for example “001” is equal to 0,1 seconds; “010” equals to 1 second.

EXAMPLE

With the need to manage various printers through the available outputs (by connecting the transmission of the printer port on the common of the outputs), as follows:

638 **SIMULATES THE PRESSURE OF A KEY**
 - 0xx simulates the pressure of the key with xx code.
 - 1xx simulates the long pressure of the key with xx code.

CODE	PRESSED KEY
00	F1 key
01	F2 key
02	F3 key
03	F4 key
04	F5 key
05	F6 key
06	F7 key
07	F8 key
08	F9 key
09	F10 key
10	Numeric key '0'
11	Numeric key '1'
12	Numeric key '2'
13	Numeric key '3'
14	Numeric key '4'
15	Numeric key '5'
16	Numeric key '6'
17	Numeric key '7'
18	Numeric key '8'
19	Numeric key '9'
20	Dot key (.)
21	ZERO key
22	Fn/ENTER key
23	2nd F key
24	C key

639 WAIT THE PRESSURE OF A KEY

- 0xx set the visualization of WAIT message and "block" the instrument, it remain on waiting of the pressure of the key with xx code.
- 1xx "block" the instrument, it remain on waiting of the pressure of the key with xx code.

640 WAIT THE STATUS OF THE INSTRUMENT

- 0xx set the visualization of WAIT message and "block" the instrument, it remain on waiting of xx status.
- 1xx "block" the instrument, it remain on waiting of xx status.

641 SET THE LEVEL OF THE FUNCTION

- 0xx set the menu level of the function that one want to perform.

642 SET THE FUNCTION

- 0xx set the code of the function that one want to perform.

Example:

To execute the function 311 is necessary insert in the format the macro 641 with 003 parameter (that set the level menu level) and the macro 642 with 011 parameter (number of the function).

643 REDIRECTION OF THE PRINT

Values valid **000**, **001** or **002**

- 000 print on Print port
- 001 print on Pc port
- 002 print on Aux port

Note: parameter 255 forces printing.

645 REDIRECT ALL THE DATA IN THE PRINT BUFFER

Values valid **000**, **001**, **002**, **003** or **004**

This macro allows to redirect and store all the data in the print buffer in order to print later.

- 000 the macro disabled.
- 001 redirect and store all the data in the print buffer and print.

- 002 just redirect and store all the data in the print buffer, but not print.
- 003 print all the data in the print buffer.
- 004 clear the print buffer.

#####

EXAMPLE

One just wants to redirect and store GROSS, TARE and NET weight in the print buffer, in order to recall and print later. One should set the following macros:

645>>> enter parameter 002

307

308

309

#####

In this way, the data will be stored in the print buffer. If one wants to print later, one should use the print macro 636 which the parameter is set at 003.

NOTE: the data stored in the print buffer is substituted until the new data is redirected.

647 WEIGHED WITHIN THE DEFINED IN THE THRESHOLD PARAMETER Valid values in the format XXX

For defining thresholds must set the bit mask of the parameter:

t3	t2	t1	TA	T1	T2	T3		THRESHOLDS
7	6	5	4	3	2	1	0	MASK BIT

EXAMPLE:

If you want it to be printed the number of weighs between threshold "t2" and "T1", it is necessary that the bits 5, 4, 3 are to 1 and all others to zero:

00111000 = 56

The parameter will be included 056

11. ELECTRICAL SCHEMES

11.1 BACK PANEL

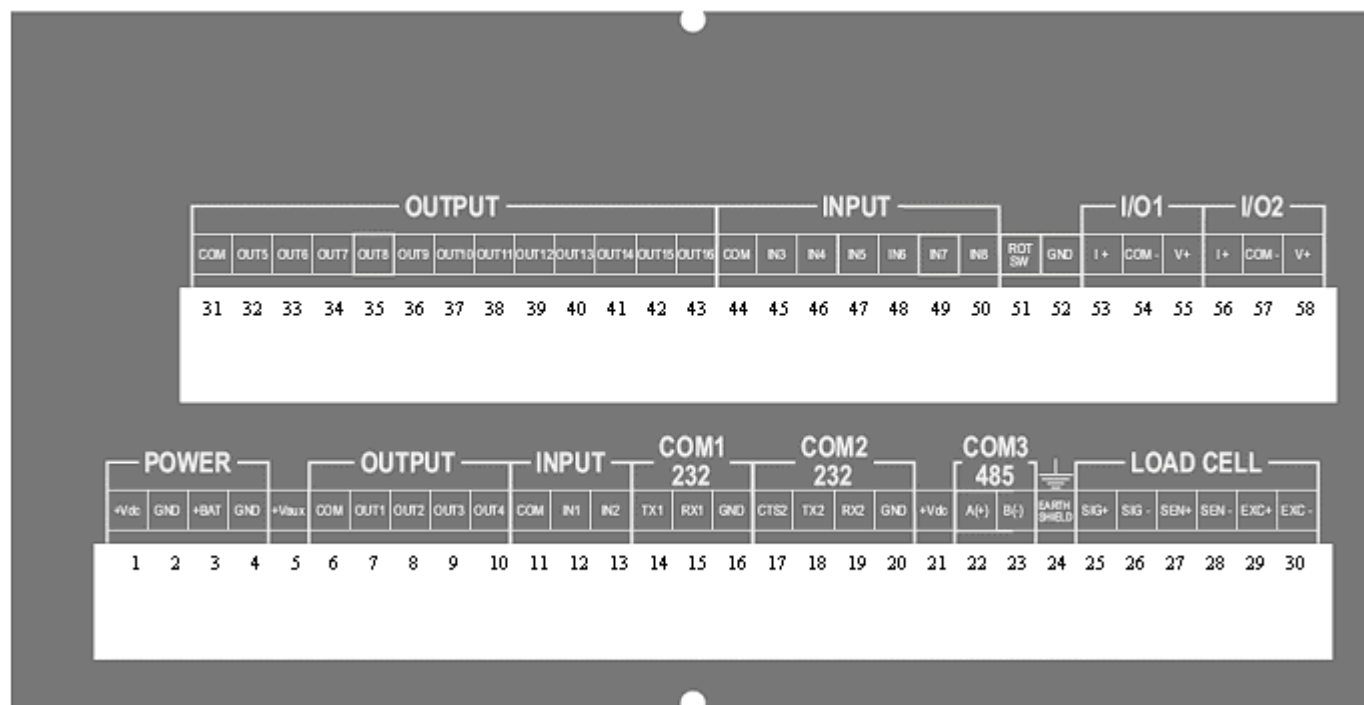

11.2 MOTHER BOARD

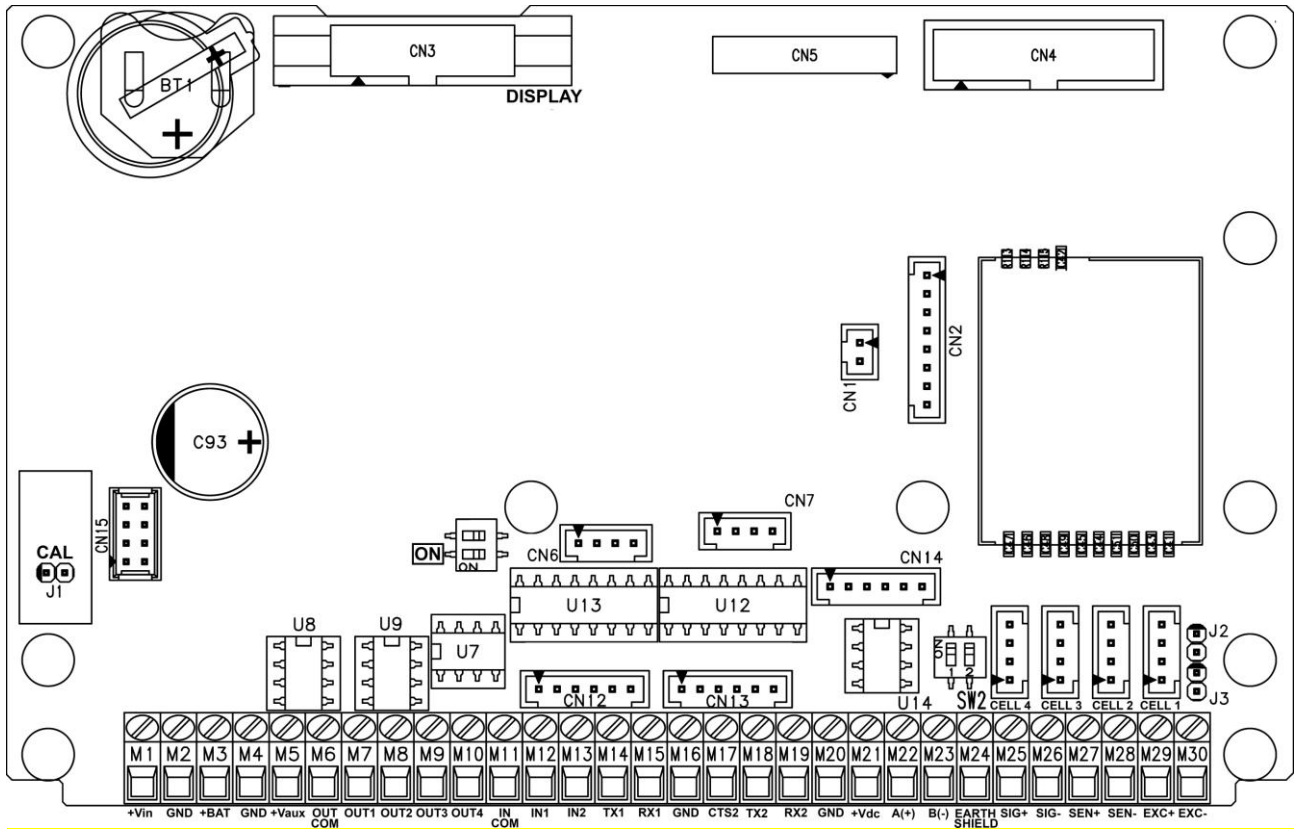

Dip Switch Logic state

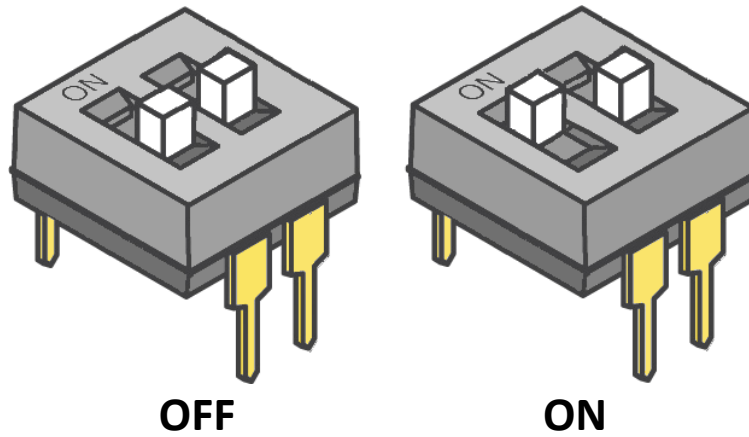

There aren't any differences between the 2 flaps, doesn't matter which one is set on to activate the switch, just turn ON only one flap

ON SW:

- If closed, one can automatically turn on the instrument, as soon as the power voltage is supplied, one must also turn off the instrument by removing the mains voltage.
- If open, one can turn the instrument on and off by just pressing the ON key.

J2, J3 (SENSE): if closed, REFERENCE + and POWER SUPPLY +, REFERENCE - and POWER SUPPLY - are jumpered on the board

J1: if opened it enables the access to the metrological parameters, when configuring.

SERIAL PORTS (refer to section 5)

COM 1	COM 2	COM 3
Connector AMP CN12: serial 232 Terminals 14-15-16: serial 232	Connector AMP CN13: serial 232 Terminals 16-17-18-19: serial 232	Connector AMP CN14: serial 232 Terminals 22-23: serial 485 (U14)

IMPORTANT:

In the case of RS485 connection, read carefully and apply what is described in chapter 5.1.

POWER SUPPLY

6 Vdc BATTERY POWER SUPPLY	+Vdc POWER SUPPLY	V-AUX AUXILIARY POWER SUPPLY	+Vdc (OUT) POWER SUPPLY
4 GND (0 Vdc) 3 +BAT (+ 6 Vdc)	2 GND (0 V) 1 +Vdc (+12 Vdc, 8 ÷ 36 Vdc with I/O expansion board connected)	4 GND (0 V) 5 +Vaux (5,3 –8 Vdc 400 mA max)	20 GND (0 V) 21 +Vdc (+12V), works only if power supply is connected

CELL LOAD RECEIVER (terminal board connection)

25	SIG+	SIGNAL +
26	SIG-	SIGNAL -
27	SENS+	SENSE +
28	SENS-	SENSE -
29	EXC+	EXCITATION +
30	EXC-	EXCITATION -

INPUTS (OPTOISOLATOR PHOTOCOUPLEDERS)

Power supply: 12 Vdc ÷ 24 Vdc max 20 mA.

PHOTOMOSFET OUTPUTS

Maximum power: 48 Vac or 60 Vdc, 150 mA max., 10 ohm max

!! IMPORTANT!!

The optoisolation of the inputs and outputs is obtained by powering the common of the outputs and/or of the inputs by using a voltage outside the instrument.

RS232 SERIAL PORT (RJ45 CONNECTOR) (*)

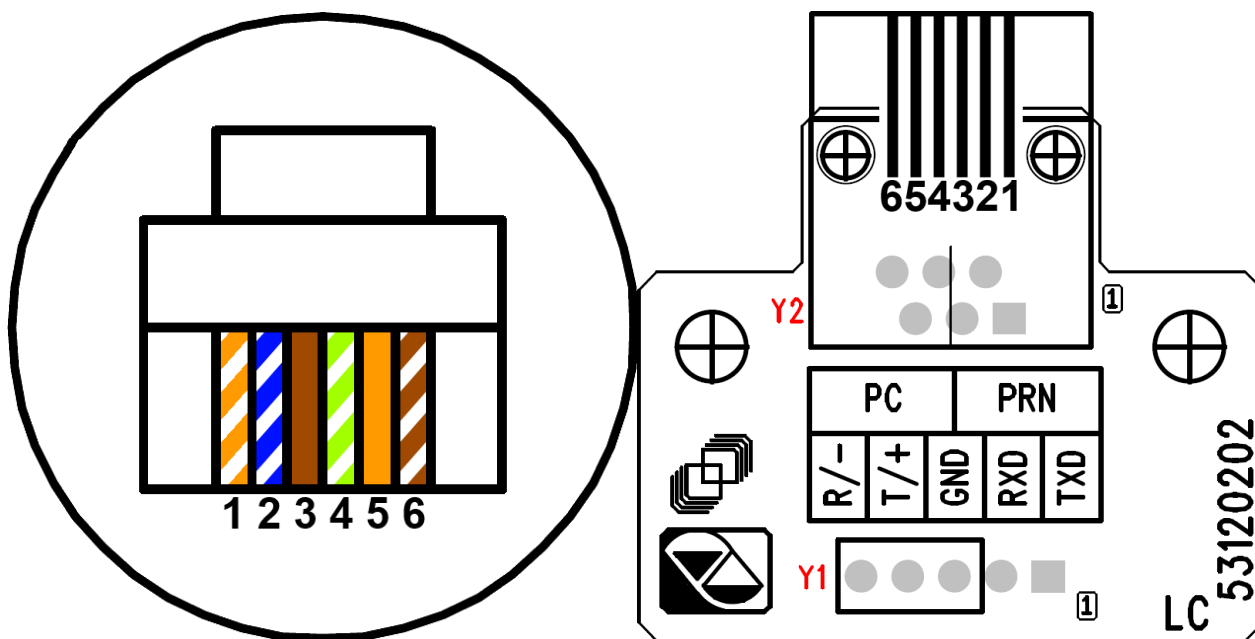

PLUG6 CONNECTIONS:

Y2	PLUG6	DB9	COLOUR		MEANING
1	1		ORANGE	WHITE	
2	2	3	BLUE	WHITE	RX
3	3		BROWN		
4	4	5	GREEN	WHITE	GND
5	5	2	ORANGE		TX
6	6		BROWN	WHITE	

(*) May be present depending on the model.

9.2 I/O EXPANSION BOARD (fitted with 3590EXT in IO version or CPWE)

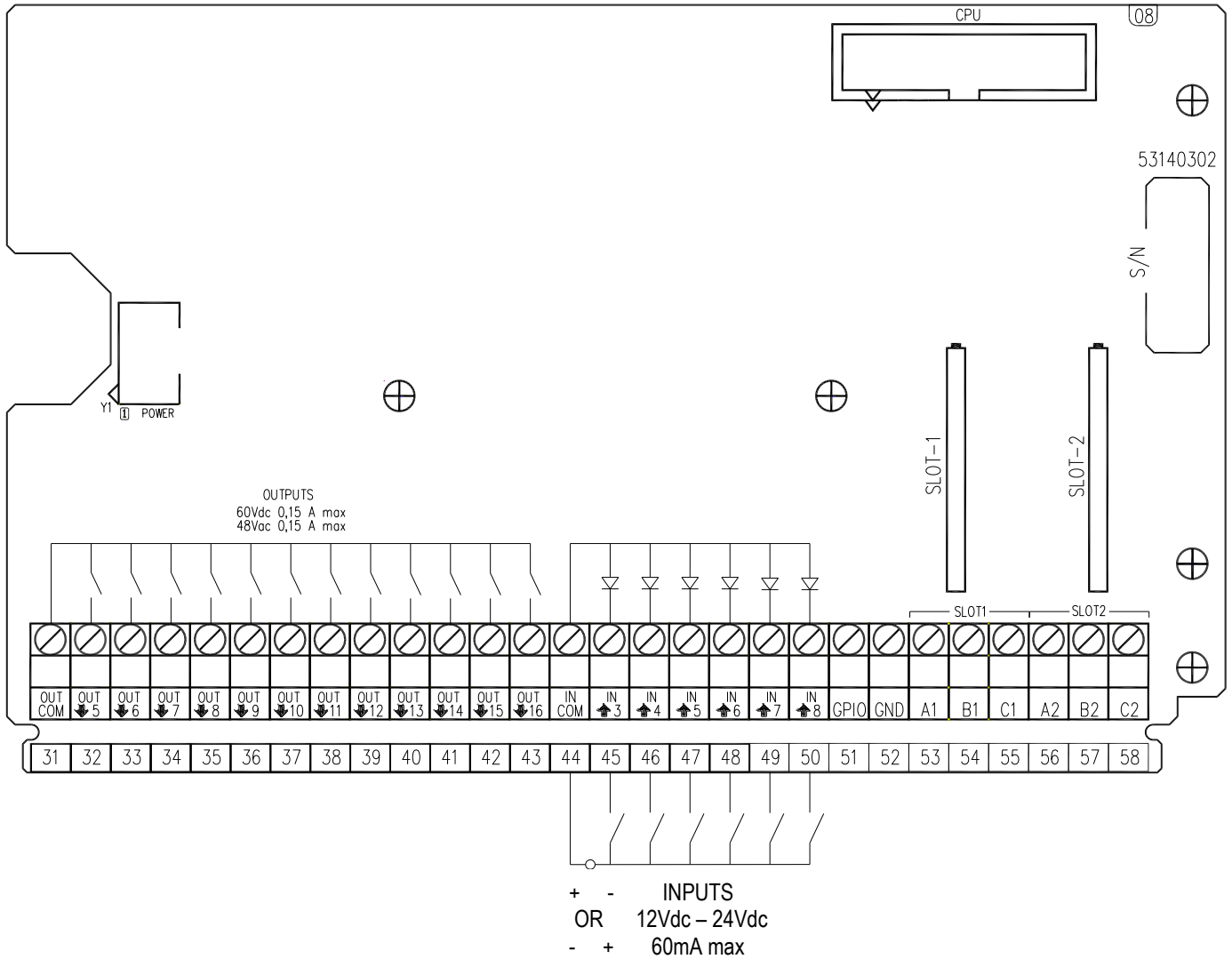

ANALOGUE OUTPUT

I/O1 (SLOT 1):		I/O2 (SLOT 2):	
53	I+ (A1) + 20 mA	56	I+ (A2) + 20 mA
54	COM- (B1) 0 mA / V	57	COM- (B2) 0 mA / V
55	V+ (C1) + 10 V	58	V+ (C2) + 10 V

Note: the maximum resistance applicable on the output current is 350 Ohm and the minimum resistance applicable on the output voltage is 10 kohm.

INPUTS (OPTOISOLATOR PHOTOCOUPLEDERS)

Power supply: 12 Vdc ÷ 24 Vdc max 20 mA.

PHOTOMOSFET OUTPUTS

Maximum power: 48 Vac or 60 Vdc, 150 mA max., 10 ohm max

!! IMPORTANT!!

The optoisolation of the inputs and outputs is obtained by powering the common of the outputs and/or of the inputs by using a voltage outside the instrument.

9.3 I/O EXPANSION SOCKET INSTALLATION

To install Inputs, outputs and RS484 IC sockets follow this procedure:

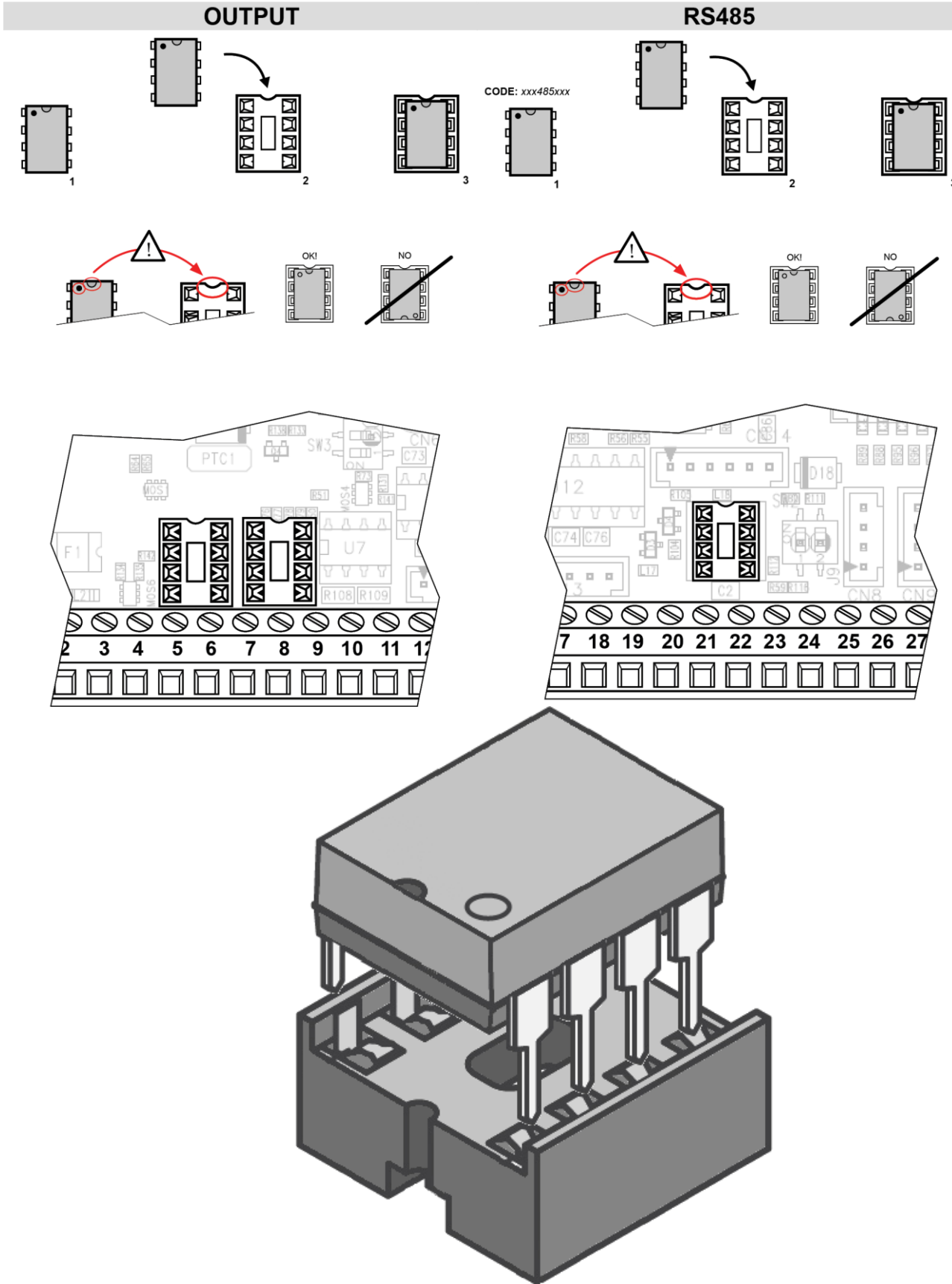

INPUT

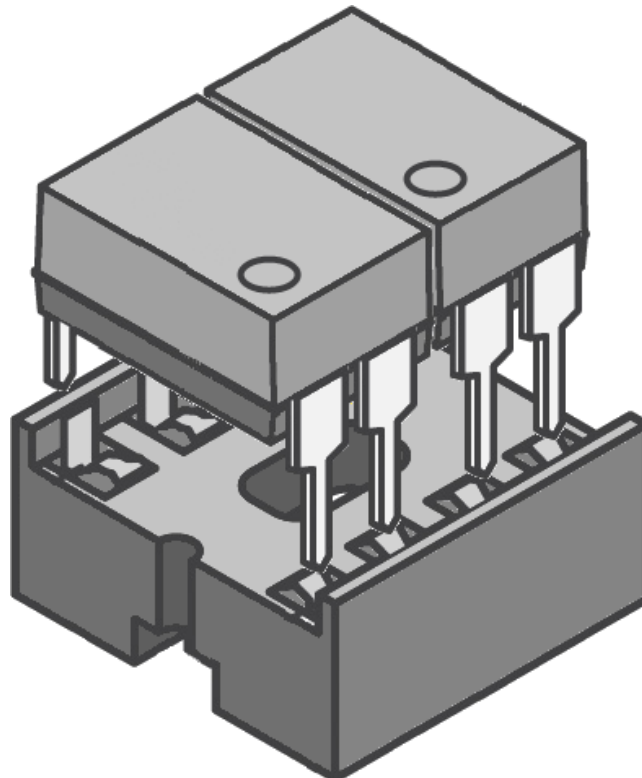
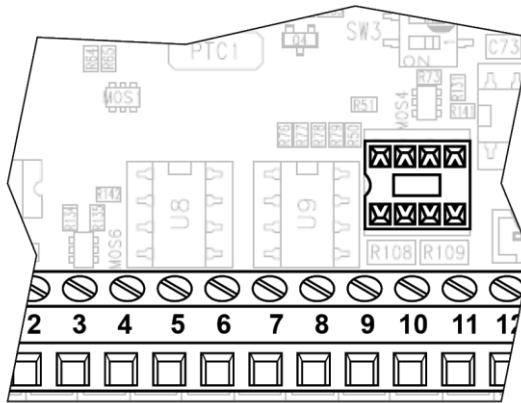
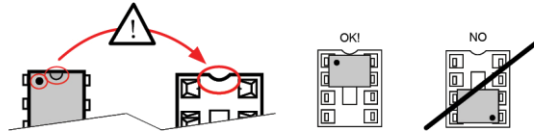
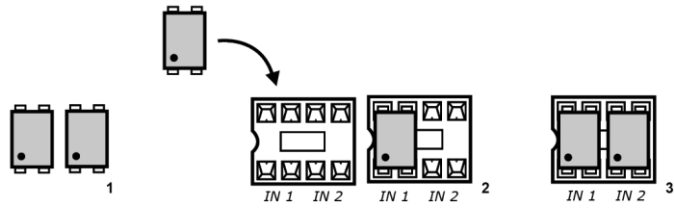

9.4 DISPLAY BOARD

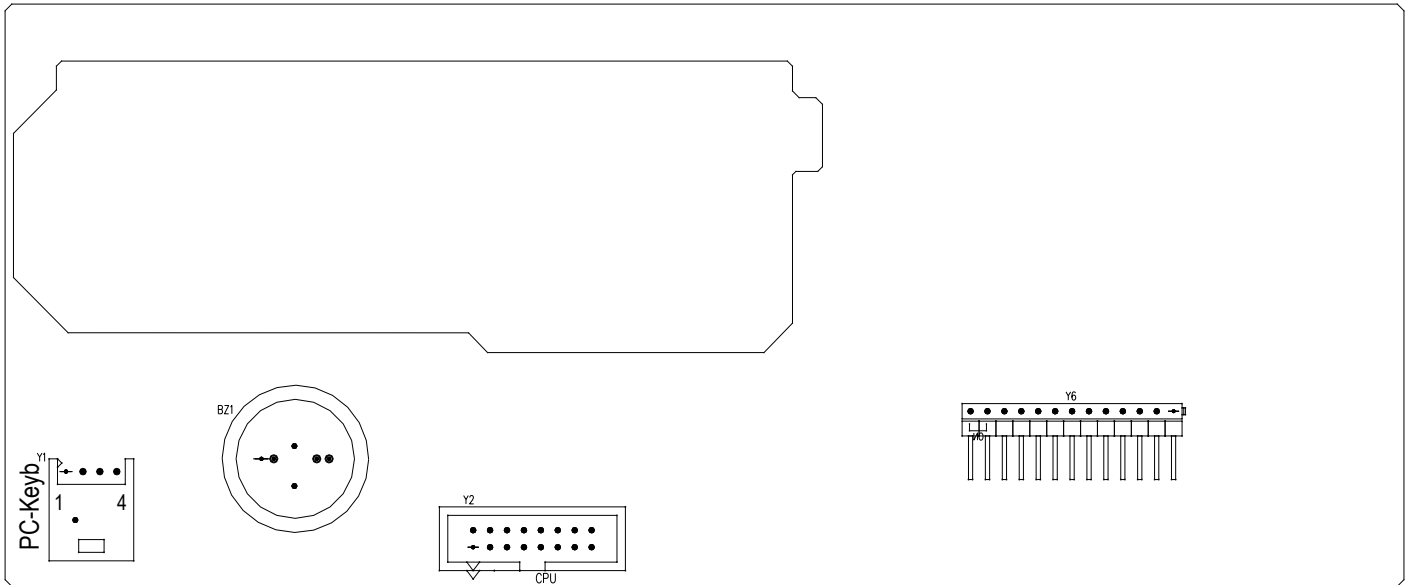

PC-Keyb – PC KEYBOARD CONNECTOR

Keyboard emulation input, usable for the connection of the instrument to the PC keyboard or the badge/bar code reader.

PC-KEYB		PS/2
1	+5V	4
2	GND	3
3	DATA	1
4	CLK	5

9.4 CONTROL LIGHT

(only for CPWET)

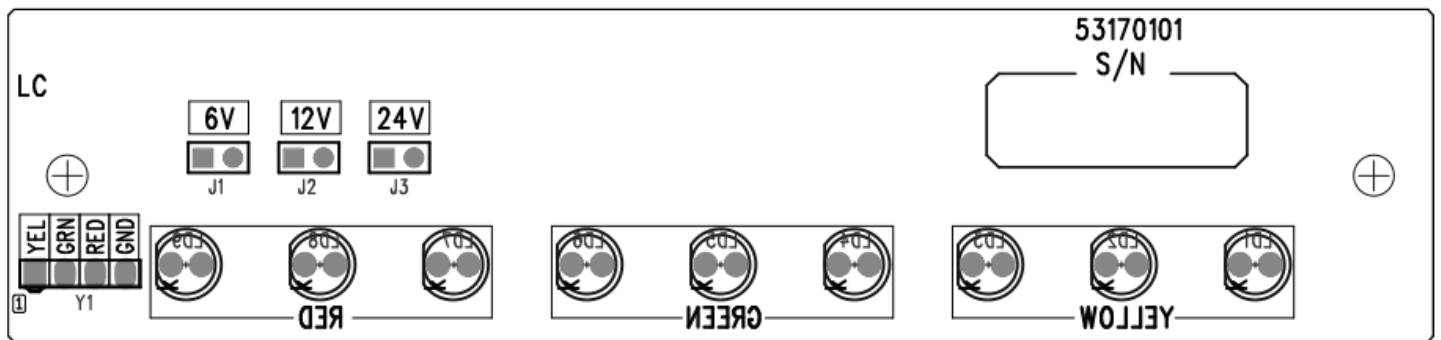

J1: if closed, allows to set the power supply of the control light to **6V**.

J2: if closed, allows to set the voltage of the control light to **12V**.

J3: not used

!!WARNING!!

Only one jumper must be closed at time

Y1	MEANING	COLOUR	MOTHERBOARD
1 (YEL)	OUT1	YELLOW	7
2 (GRN)	OUT2	GREEN	8
3 (RED)	OUT3	BROWN	9
4 (GND)	GND	WHITE	20